

SYLVANIA

13 inch COLOR TV/DVD

Owner's Manual 6513DG

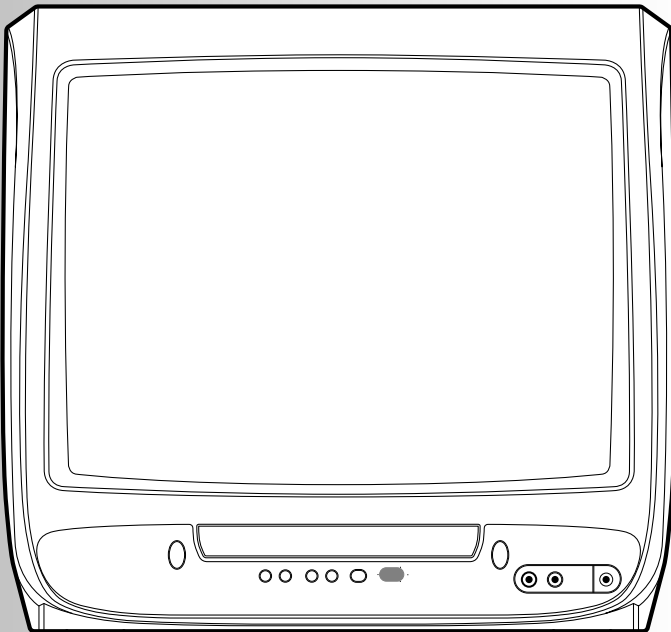

FEATURES

- Auto Channel Programming
- Screen Saver
- Auto Power Off
- Parental Lock
- Resume Play
- Closed Caption Decoder

SUPPLIED ACCESSORIES

This unit comes with the following accessories. Please confirm that all the accessories are included.

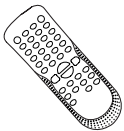

Remote Control
(NF100UD)

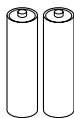

AA batteries x 2

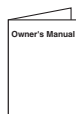

Owner's Manual
(1EMN21312)

INSTRUCCIONES EN ESPAÑOL INCLUIDAS

PLEASE READ BEFORE USING THIS EQUIPMENT

**IF YOU NEED ADDITIONAL ASSISTANCE FOR SET-UP OR OPERATING
AFTER READING OWNER'S MANUAL,
PLEASE CALL TOLL FREE 1-800-968-3429 OR VISIT OUR WEB SITE AT
<http://www.SylvaniaConsumerElectronics.com>**

PRECAUTIONS

WARNING: TO REDUCE THE RISK OF FIRE OR ELECTRIC SHOCK, DO NOT EXPOSE THIS APPLIANCE TO RAIN OR MOISTURE.



CAUTION: TO REDUCE THE RISK OF ELECTRIC SHOCK, DO NOT REMOVE COVER (OR BACK). NO USER SERVICEABLE PARTS INSIDE. REFER SERVICING TO QUALIFIED SERVICE PERSONNEL.

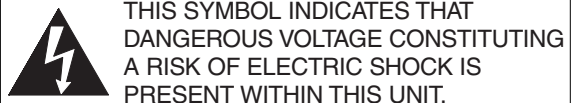

THIS SYMBOL INDICATES THAT DANGEROUS VOLTAGE CONSTITUTING A RISK OF ELECTRIC SHOCK IS PRESENT WITHIN THIS UNIT.



THIS SYMBOL INDICATES THAT THERE ARE IMPORTANT OPERATING AND MAINTENANCE INSTRUCTIONS IN THE LITERATURE ACCOMPANYING THE APPLIANCE.

The caution marking is located on the rear of the cabinet.

IMPORTANT SAFEGUARDS

- 1. Read instructions** - All the safety and operating instructions should be read before the appliance is operated.
- 2. Retain Instructions** - The safety and operating instructions should be retained for future reference.
- 3. Heed Warnings** - All warnings on the appliance and in the operating instructions should be adhered to.
- 4. Follow Instructions** - All operating and use instructions should be followed.
- 5. Cleaning** - Unplug the unit from the wall outlet before cleaning. Do not use liquid cleaners or aerosol cleaners. Use a damp cloth for cleaning.
EXCEPTION: A product that is meant for uninterrupted service and, that for some specific reason, such as the possibility of the loss of an authorization code for a CATV converter, is not intended to be unplugged by the user for cleaning or any other purpose, may exclude the reference to unplugging the appliance in the cleaning description otherwise required in item 5.
- 6. Attachments** - Do not use attachments not recommended by the unit manufacturer as they may cause hazards.
- 7. Water and Moisture** - Do not use this unit near water - for example, near a bath tub, wash bowl, kitchen sink, or laundry tub, in a wet basement, or near a swimming pool, and the like.
- 8. Accessories** - Do not place this unit on an unstable cart, stand, tripod, bracket, or table. The unit may fall, causing serious injury to someone, and serious damage to the appliance. Use only with a cart, stand, tripod, bracket, or table recommended by the manufacturer, or sold with the unit. Any mounting of the appliance should follow the manufacturer's instructions and should use a mounting accessory recommended by the manufacturer. An appliance and cart combination should be moved with care. Quick stops, excessive force, and uneven surfaces may cause the appliance and cart combination to overturn.

PORTABLE CART WARNING



SYMBÔLE D'AVERTISSEMENT POUR LES COMPOSANTES APPAREIL ET MEUBLE À ROULETTES



- Ameubles** - Cet appareil ne doit être placé que sur un meuble (avec ou sans roulettes) recommandé par le fabricant. Si vous l'installez sur un meuble à roulettes, déplacez les deux ensembles avec précaution. Un arrêt brusque, l'utilisation d'une force excessive et des surfaces irrégulières risquent de déstabiliser l'ensemble et de le renverser.
- 9. Ventilation** - Slots and openings in the cabinet and the back or bottom are provided for ventilation and to ensure reliable operation of the unit and to protect it from overheating, and

these openings must not be blocked or covered. The openings should never be blocked by placing the unit on a bed, sofa, rug, or other similar surface. This unit should never be placed near or over a radiator or heat register. This unit should not be placed in a built-in installation such as a bookcase or rack unless proper ventilation is provided or the manufacturer's instructions have been adhered to.

- 10. Power Sources** - This unit should be operated only from the type of power source indicated on the marking label. If you are not sure of the type of power supply to your home, consult your appliance dealer or local power company. For the units intended to operate from battery power, or other sources, refer to the operating instructions.
- 11. Grounding or Polarization** - This unit is equipped with a polarized alternating-current line plug (a plug having one blade wider than the other). This plug will fit into the power outlet only one way. This is a safety feature. If you are unable to insert the plug fully into the outlet, try reversing the plug. If the plug should still fail to fit, contact your electrician to replace your obsolete outlet. Do not defeat the safety purpose of the polarized plug.
- 12. Power-Cord Protection** - Power-supply cords should be routed so that they are not likely to be walked on or pinched by items placed upon or against them, paying particular attention to cords at plugs, convenience receptacles, and the point where they exit from the appliance.
- 13. Outdoor Antenna grounding** - If an outside antenna or cable system is connected to the unit, be sure the antenna or cable system is grounded so as to provide some protection against voltage surges and built-up static charges. Article 810 of the National Electrical Code, ANSI/NFPA No. 70, provides information with respect to proper grounding of the mast and supporting structure, grounding of the lead-in wire to an antenna discharge unit, size of grounding conductors, location of antenna-discharge unit, connection to grounding electrodes, and requirements for the grounding electrode. (Fig. A)

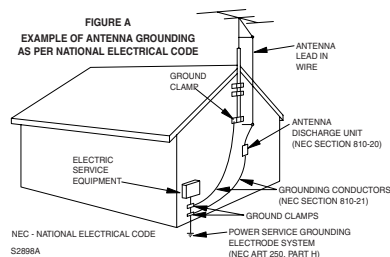

-
- 14. Lightning** - For added protection for this unit receiver during a lightning storm, or when it is left unattended and unused for long periods of time, unplug it from the wall outlet and disconnect the antenna or cable system. This will prevent damage to the unit due to lightning and power-line surges.
- 15. Power Lines** - An outside antenna system should not be located in the vicinity of overhead power lines or other electric light or power circuits, or where it can fall into such power lines or circuits. When installing an outside antenna system, extreme care should be taken to keep from touching such power lines or circuits as contact with them might be fatal.
- 16. Overloading** - Do not overload wall outlets and extension cords as this can result in a risk of fire or electric shock.
- 17. Object and Liquid Entry** - Never push objects of any kind into this unit through openings as they may touch dangerous voltage points or short out parts that could result in a fire or electric shock. Never spill liquid of any kind on the unit.
- 18. Servicing** - Do not attempt to service this unit yourself as opening or removing covers may expose you to dangerous voltage or other hazards. Refer all servicing to qualified service personnel.
- 19. Damage Requiring Service** - Unplug this unit from the wall outlet and refer servicing to qualified service personnel under the following conditions:
- a. When the power-supply cord or plug is damaged or frayed.
 - b. If liquid has been spilled, or objects have fallen into the unit.
 - c. If the unit has been exposed to rain or water.
 - d. If the unit does not operate normally by following the operating instructions. Adjust only those controls that are covered by the operating instructions, as improper adjustment of other controls may result in damage and will often require extensive work by a qualified technician to restore the unit to its normal operation.
 - e. If the unit has been dropped or damaged in any way.
 - f. When the unit exhibits a distinct change in performance, this indicates a need for service.
- 20. Replacement Parts** - When replacement parts are required, be sure the service technician has used replacement parts specified by the manufacturer that have the same characteristics as the original part. Unauthorized substitutions may result in fire, electric shock, injury to persons or other hazards.
- 21. Safety Check** - Upon completion of any service or repairs to this unit, ask the service technician to perform routine safety checks to determine that the unit is in proper operating condition.
- 22. Heat** - This unit product should be situated away from heat sources such as radiators, heat registers, stoves, or other products (including amplifiers) that produce heat.
-

IMPORTANT COPYRIGHT INFORMATION

Unauthorized copying, broadcasting, public performance and lending of discs are prohibited. This product incorporates copyright protection technology that is protected by U.S. patents and other intellectual property rights. Use of this copyright protection technology must be authorized by Macrovision, and is intended for home and other limited viewing uses only unless otherwise authorized by Macrovision. Reverse engineering or disassembly is prohibited.

RADIO-TV INTERFERENCE

This equipment has been tested and found to comply with the limits for a Class B digital device, pursuant to Part 15 of the FCC Rules. These limits are designed to provide reasonable protection against harmful interference in a residential installation. This equipment generates, uses, and can radiate radio frequency energy and, if not installed and used in accordance with the instructions, may cause harmful interference to radio communications. However, there is no guarantee that interference will not occur in a particular installation. If this equipment does cause harmful interference to radio or television reception, which can be determined by turning the equipment off and on, the user is encouraged to try to correct the interference by one or more of the following measures:

- 1) Reorient or relocate the receiving antenna.
- 2) Increase the separation between the equipment and receiver.
- 3) Connect the equipment into an outlet on a circuit different from that to which the receiver is connected.
- 4) Consult the dealer or an experienced radio/TV technician for help.

This Class B digital apparatus complies with Canadian ICES-003.

Cet appareil numérique de la classe B est conforme à la norme NMB-003 du Canada.

FCC WARNING- This equipment may generate or use radio frequency energy. Changes or modifications to this equipment may cause harmful interference unless the modifications are expressly approved in the owner's manual. The user could lose the authority to operate this equipment if an unauthorized change or modification is made.

LASER SAFETY

This unit employs a laser. Only a qualified service person should remove the cover or attempt to service this device, due to possible eye injury.

CAUTION: USE OF CONTROLS OR ADJUSTMENTS OR PERFORMANCE OF PROCEDURES OTHER THAN THOSE SPECIFIED HEREIN MAY RESULT IN HAZARDOUS RADIATION EXPOSURE.

CAUTION: VISIBLE AND INVISIBLE LASER RADIATION WHEN OPEN AND INTERLOCK DEFEATED. DO NOT STARE INTO BEAM.

LOCATION: INSIDE, NEAR THE DECK MECHANISM.

CAUTION: TO PREVENT ELECTRIC SHOCK, MATCH WIDE BLADE OF PLUG TO WIDE SLOT, FULLY INSERT.

ATTENTION: POUR ÉVITER LES CHOC ÉLECTRIQUES, INTRODUIRE LA LAME LA PLUS LARGE DE LA FICHE DANS LA BORNE CORRESPONDANTE DE LA PRISE ET POUSSER JUSQU'AU FOND.

Note to CATV system installer:

This reminder is provided to call the CATV system installer's attention to Article 820-40 of the NEC that provides guidelines for proper grounding and in particular, specifies that the cable ground shall be connected to the grounding system of the building as close to the point of cable entry as practical.

LOCATION

For safe operation and satisfactory performance of the unit, keep the following in mind when selecting a place for its installation:

- Shield it from direct sunlight and keep it away from sources of intense heat.
- Avoid dusty or humid places.
- Avoid places with insufficient ventilation for proper heat dissipation. Do not block the ventilation holes at the top and bottom of the unit. Do not place the unit on a carpet because this will block the ventilation holes.
- Install unit in a horizontal position.
- Avoid locations subject to strong vibration.
- Do not place the unit near strong magnetic fields.
- Avoid moving unit to locations where temperature differences are extreme.
- Be sure to remove disc and unplug the AC power cord from the outlet before carrying the unit.

TO AVOID THE HAZARDS OF ELECTRICAL SHOCK AND FIRE

- Do not handle the power cord with wet hands.
- Do not pull on the power cord when disconnecting it from an AC wall outlet. Grasp it by the plug.
- If, by accident, water is spilled on your unit, unplug the power cord immediately and take the unit to our Authorized Service Center for servicing.
- Do not put your fingers or objects into the unit disc loading tray.
- Do not place anything directly on top of the unit.

MOISTURE WARNING

- Moisture condensation may occur inside the unit when it is moved from a cold place to a warm place, or after heating a cold room or under conditions of high humidity. If you play a videotape or DVD in a moist unit, it may damage the tape or DVD and the unit. When the condensation occurs inside the unit, turn the unit on and leave it at least 2 hours to dry out.

NOTE ABOUT RECYCLING

Batteries should never be thrown away or incinerated but disposed of in accordance with your local regulations concerning chemical wastes.

Manufactured under license from Dolby Laboratories.

"Dolby" and the double-D symbol are trademarks of Dolby Laboratories.

The serial number of this product may be found on the back of the unit. No other unit has the same serial number as yours. You should record the number and other vital information here and retain this book as a permanent record of your purchase to aid identification in case of theft. Serial numbers are not kept on file.

Date of Purchase		Dealer Phone No.	
Dealer Purchase from		Model No.	
Dealer Address		Serial No.	

TABLE OF CONTENTS

PRECAUTIONS	2	PLAYING A DISC	15
IMPORTANT SAFEGUARDS	2	BASIC PLAYBACK	15
TABLE OF CONTENTS	5	DISC MENU / TITLE MENU	15
SYMBOLS USED IN THIS MANUAL	5	SPECIAL PLAYBACK FUNCTIONS & SETTINGS ..	16
PREPARATION FOR USE	6	FUNCTION TABLE	16
ANTENNA/CABLE CONNECTIONS	6	AUDIO MENU	17
CONNECTING TO AN EXTERNAL DEVICE (FRONT) ..	7	SUBTITLE LANGUAGE	17
INSTALLING THE BATTERIES IN REMOTE CONTROL ..	7	ANGLE MENU	17
OPERATING CONTROLS AND FUNCTIONS ...	8	ZOOM	17
		BLACK LEVEL MENU	18
		SEARCH MENU	18
		REPEAT PLAYBACK	19
		PROGRAMMED PLAYBACK	20
		RANDOM PLAYBACK	20
		ON-SCREEN INFORMATION	20
		CHANGING THE DVD SET UP ITEMS	21
		CUSTOM MENU	21
		INITIALIZE	23
		TROUBLESHOOTING GUIDE	24
		MAINTENANCE	26
		APPENDIX	27
		CABLE CHANNEL DESIGNATIONS	27
		LANGUAGE CODE LIST	27
		SPECIFICATIONS	28
		ESPAÑOL	29
		WARRANTY	BACK COVER

TV SECTION





TV OPERATION AND SETTINGS	9
INITIAL SET UP	9
WATCHING A TV PROGRAM	9
SLEEP TIMER / PICTURE CONTROL	10
CLOSED CAPTION SYSTEM	10
CHANNEL SET UP	11
ON-SCREEN MENU LANGUAGE	11
V-CHIP SET UP	12

DVD SECTION

ABOUT THE DISCS	14
PLAYABLE DISCS	14
UNPLAYABLE DISCS	14

SYMBOLS USED IN THIS MANUAL

The following symbols below appear in some headings and notes in this manual, with the following meanings.

	Description refers to TV operation (in the TV mode).		Description refers to playback of audio CDs (in the DVD mode).
	Description refers to playback of DVD video discs (in the DVD mode).		Description refers to the items to be set by the QUICK mode (in the DVD mode).

PREPARATION FOR USE

ANTENNA/CABLE CONNECTIONS

Plug the incoming cable into the ANT. jack on the rear of the unit.

If your cable service supplies you with a converter box or if you use a satellite system, connect the box with this unit as shown below.

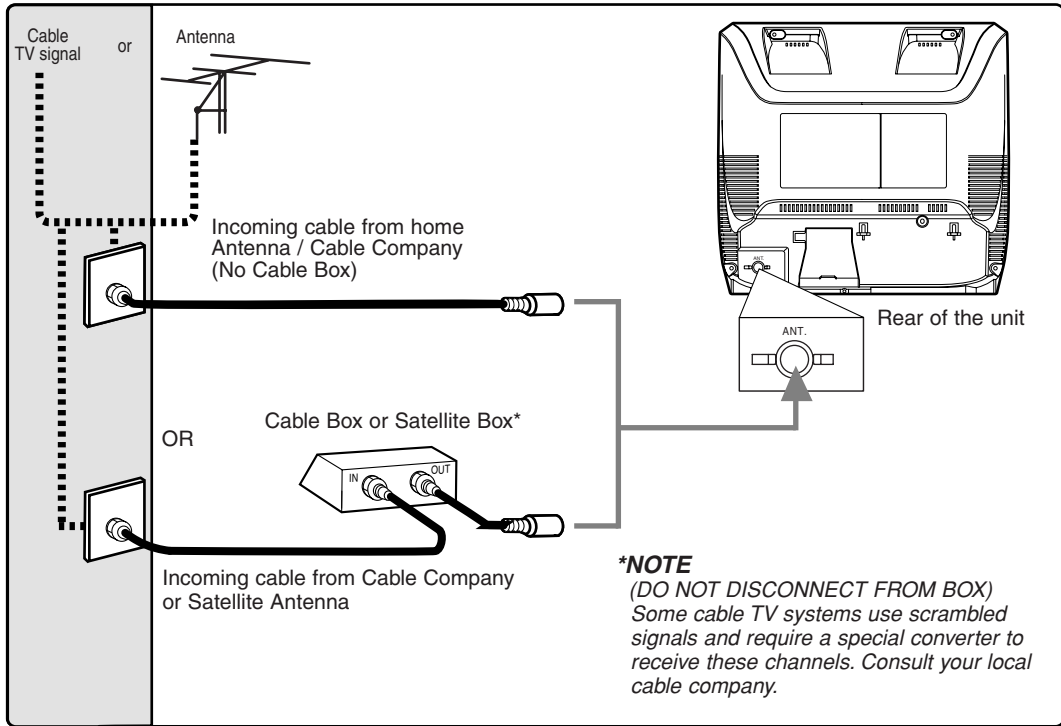

NOTE:

Before plugging the antenna into the ANT. jack of the unit, check that the pin is not bent. If it is bent, straighten the pin as illustrated, then plug the pin into the ANT. jack of the unit.

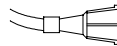
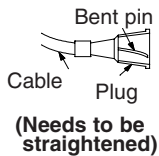

For your safety and to avoid damages to the unit, unplug the antenna cable from the ANT. jack before moving the unit.

CONNECTING TO AN EXTERNAL DEVICE (FRONT)

When you watch a program recorded on another source (VCR or video camera), use the AUDIO/VIDEO input jacks on the front of the unit.
Connect the Audio/Video output jacks of another source to the AUDIO and VIDEO jacks of this unit.

Then use [SELECT] or [CH. ▲ / ▼] until "AUX" appears on the screen.

AUX

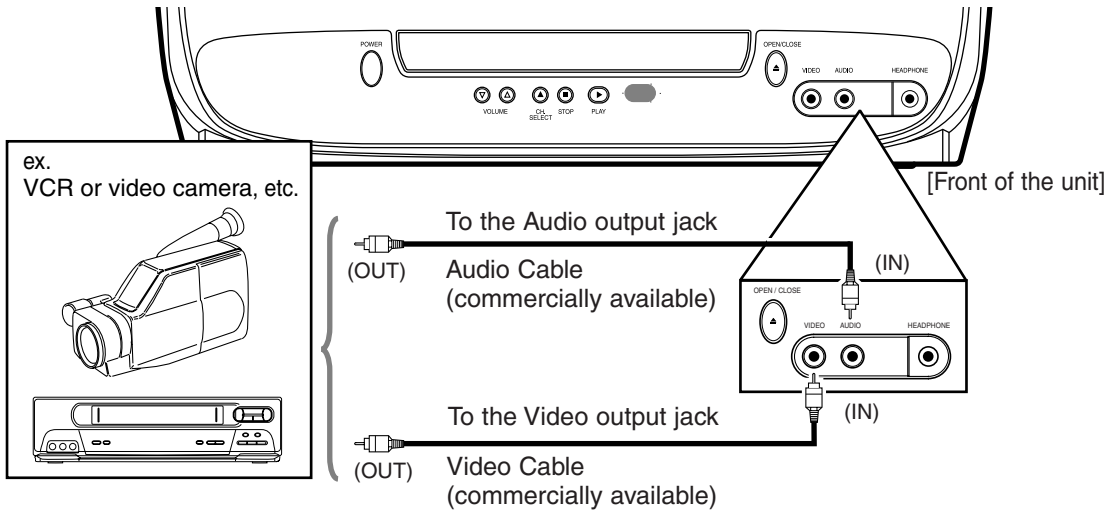

INSTALLING THE BATTERIES IN REMOTE CONTROL

- 1) Open the battery compartment cover by pressing the cover on the remote unit in the direction of the arrow.
- 2) Insert 2 "AA" penlight batteries into the battery compartment in the direction indicated by the polarity (+/-) markings.
- 3) Replace the cover.

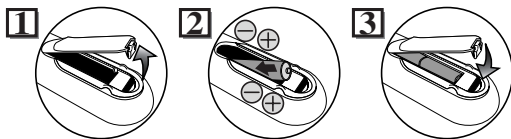

[BATTERY PRECAUTIONS]

- Be sure to follow the correct polarity as indicated in the battery compartment. Reversed batteries may cause damage to the device.
- Do not mix different types of batteries together (e.g. Alkaline and Carbon-Zinc) or old batteries with fresh ones.
- If the device is not to be used for a long period of time, remove the batteries to prevent damage or injury from possible battery leakage.
- Do not try to recharge batteries not intended to be recharged; they can overheat and rupture.

OPERATING CONTROLS AND FUNCTIONS

- FRONT PANEL -

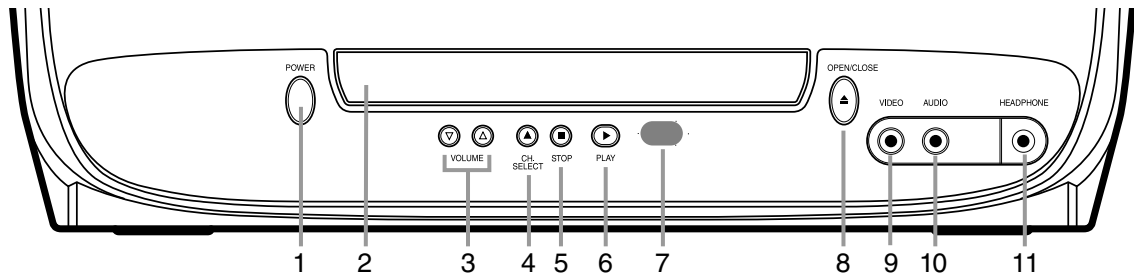

- REMOTE CONTROL -

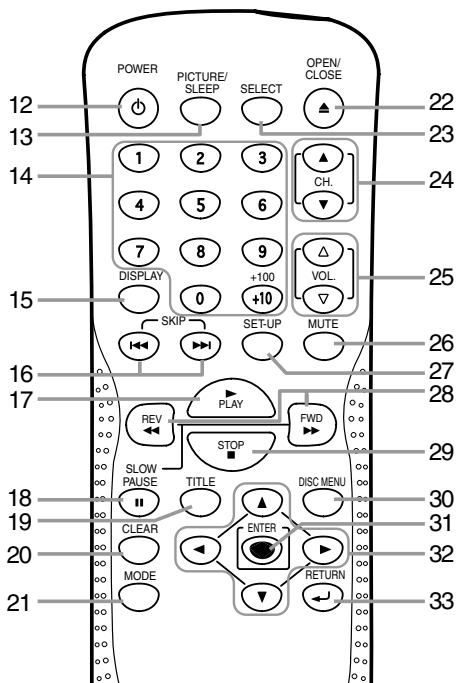

[FRONT PANEL]

- 1 POWER Button [TV P.9 / DVD P.15]
- 2 Disc loading tray
- 3 VOLUME Δ / ∇ Buttons [P.9]
- 4 CHANNEL SELECT \blacktriangle Button [TV P.9]
- 5 STOP \blacksquare Button [DVD P.15]
- 6 PLAY \blacktriangleright Button [TV P.9 / DVD P.15]
- 7 Remote sensor window
- 8 OPEN/CLOSE \blacktriangle Button [DVD P.15]
- 9 VIDEO input Jack [P.7]
- 10 AUDIO input Jack [P.7]
- 11 HEADPHONE Jack

[REMOTE CONTROL]

- 12 POWER Button [TV P.9 / DVD P.15]
- 13 PICTURE/SLEEP Button [TV P.10]
- 14 Number Buttons [TV P.9 / DVD P.18]
- 15 DISPLAY Button [DVD P.20]
- 16 SKIP \blacktriangleleft / \blacktriangleright Buttons [DVD P.18]
- 17 PLAY \blacktriangleright Button [TV P.9 / DVD P.15]
- 18 PAUSE \parallel Button [DVD P.15]
- 19 TITLE Button [DVD P.15]
- 20 CLEAR Button [TV P.10 / DVD P.18]
- 21 MODE Button [DVD P.16]
- 22 OPEN/CLOSE \blacktriangle Button [DVD P.15]
- 23 SELECT Button [TV P.9]
- 24 CH. \blacktriangle / \blacktriangledown Buttons [TV P.9]
- 25 VOL. Δ / ∇ Buttons [TV P.9]
- 26 MUTE Button [TV P.9]
- 27 SET-UP Button [TV P.10 / DVD P.21]
- 28 REV \blacktriangleleft Button [DVD P.15]
- FWD \blacktriangleright Button [DVD P.15]
- 29 STOP \blacksquare Button [DVD P.15]
- 30 DISC MENU Button [DVD P.15]
- 31 ENTER Button [TV P.10 / DVD P.15]
- 32 \blacktriangle / \blacktriangledown / \blacktriangleleft / \blacktriangleright Buttons [TV P.10 / DVD P.15]
- 33 RETURN Button [DVD P.17]

NOTE:

- We do not recommend the use of universal remote controls as it does not control all the functions. Note that the code number given by universal remote controls may not program to this unit. For more details, contact the manufacturer of the universal remote control.
- Unless stated, all operations described are based on remote control use. Some operations can be carried out using the menu bar on the TV screen.

T V OPERATION AND SETTINGS

INITIAL SET UP

When you turn on the power for the first time, the INITIAL LANGUAGE screen is displayed. Select the language for screen display and perform auto programming of the channels.

1 After antenna or cable connection is completed, connect the power cord into a standard AC outlet.



2 Press [POWER] to turn on the unit.

3 Press one of the keys listed below to select the language of on-screen menu.

- ENGLISH: [VOL. ▽]
- ESPAÑOL: [VOL. △]
- FRANÇAIS: [CH. ▲]

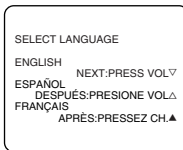

4 Confirm the antenna (or cable) connection and press [PLAY ►].

- The tuner scans and memorizes all active channels in your area.

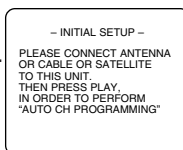

5 When the scanning is completed, the tuner stops on the lowest memorized channel.

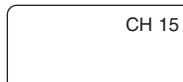

(Example)

NOTES:

- You can exit the INITIAL SETUP menu by pressing [SET-UP]. If the button is pressed during channel scanning, the tuner stops scanning and the lowest memorized channel is displayed.
- The INITIAL SETUP menu is displayed every time you turn on the unit unless the scanning is completed.
- In case no channel can be received by the channel scanning, "NO TV SIGNALS" is displayed on the screen. Turn off the unit and check the antenna connection, then follow steps 1 to 5 again.
- You can change the setting after completing INITIAL SETUP by LANGUAGE menu or CHANNEL SET UP menu. (Refer to "ON-SCREEN MENU LANGUAGE" or "CHANNEL SET UP" on page 11).

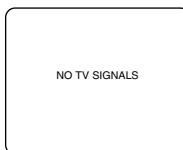

WATCHING A TV PROGRAM

1 Press [POWER] to turn on the unit.

NOTES:

If the TV screen shows snow noise and there is no operation for more than 10 seconds, "HELPFUL HINTS" appears.

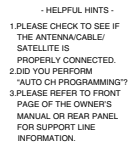

- Make sure if the antenna or cable is connected properly. (Refer to "ANTENNA/CABLE CONNECTIONS on page 6.)
- Set the "AUTO CH PROGRAMMING" in the CHANNEL SET UP. (Refer to "CHANNEL SET UP" on page 11.)
- If those setting do not work properly, please call our help line on the front page of this owner's manual.

2 Use [CH. ▲ / ▼] or the Number buttons to select your desired channel number.

To use the number buttons

- Single digit channels: (Ex. 02, 03, 04 and so on) Press [0] first to select a single digit channel.
- Two digit channels: (Ex. 12, 38, 95 ...)
Press two digits directly.
- Tree digit channels: (Ex. 115, 125 ...)
Press [+100] first, then press the last two digits.

3 Use [VOL. △ / ▼] to adjust the volume.

Press [MUTE] to instantly mute the sound. Press it again to restore the previous sound level.



NOTE:

- Even if you turn off the unit in the DVD mode, the unit will be in the TV mode when you turn it on again.

TO WATCH CABLE OR SATELLITE CHANNEL

If the unit is connected to a cable box or satellite box, use [CH. ▲ / ▼] to select CH3 or CH4 according to the output channel setting of the device and select desired channel on that device.

TO WATCH EXTERNAL INPUT

When an external equipment is connected to the front AUDIO/VIDEO input jacks, press [SELECT] or [CH. ▲ / ▼] repeatedly until "AUX" appears on the screen.



TV OPERATION AND SETTINGS

SLEEP TIMER / PICTURE CONTROL

You can set Sleep Timer and picture adjustment with [PICTURE / SLEEP]. 

- The menu changes as described below every time you press [PICTURE / SLEEP].

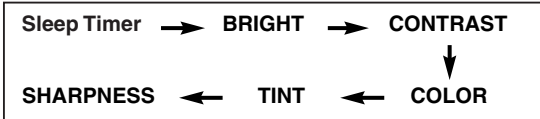

SLEEP TIMER SETTING

The Sleep Timer function is used to turn off the unit without pressing [POWER] after a desired time.

1 Press [PICTURE / SLEEP] to display the Sleep Timer menu. 

2 Within 10 seconds, set your desired sleep time using [◀ / ▶].

- [▶]...Increase by 10 min. (Up to 120 min.)
- [◀]...Decrease by 10 min.

NOTE:

- To cancel the Sleep Timer, use [CLEAR] or [◀ / ▶] to set the time to "0".

3 To confirm the remainder time to shutdown, press [PICTURE / SLEEP].

PICTURE CONTROL

The picture controls are preset to factory defaults, but you can change them to your desired setting.

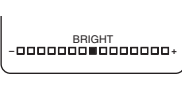
1 Press [PICTURE / SLEEP] repeatedly until desired control is displayed. 

2 Use [◀ / ▶] to adjust to your desired level within 5 seconds.

	◀	▶
BRIGHT	to decrease brightness	to increase brightness
CONTRAST	to decrease contrast	to increase contrast
COLOR	to pale	to brilliant
TINT	to purple	to green
SHARPNESS	to soft	to clear

- Even if any power failure occurs, the unit will retain its memory for this feature.

CLOSED CAPTION SYSTEM

You can view specially labeled (cc) TV programs, movies, news and pre-recorded tapes with either a dialogue caption or text display. 

1 Press [SET-UP].

Use [▲ / ▼] to point to "CAPTION".

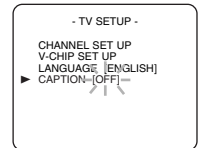

2 Press [ENTER] repeatedly to select your desired caption mode.

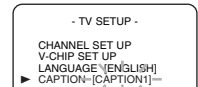

- **CAPTION mode:** You can watch dramas, movies and news while captioning the dialogues and the contents of news.
- **TEXT mode:** You can watch half screen text information if you want.
- **CAPTION2" is usually used for a second language (if available).

3 Press [SET-UP] to exit the menu.

NOTES:

- Even if any power failure, the unit will retain its memory for this feature.
- Some programs are not broadcasted with closed captions. The unit is designed to provide error-free closed captions with high quality antenna, cable and VCR signals. Conversely, poor quality signals are likely to result in caption errors or no captions at all.
- Common signal conditions which may cause caption errors are listed below:
 - Weak snowy reception on TV screen
 - Multiplex signal reception displaying picture ghosts or airplane flutter
- If the unit displays a black box on the TV screen, this means that the unit is set to the TEXT mode. To clear screen, select "CAPTION1", "CAPTION2" or "OFF".

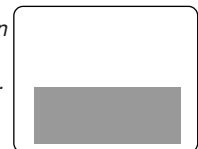

TO CANCEL THE CLOSED CAPTION SYSTEM

1 Press [SET-UP]. Use [▲ / ▼] to point to "CAPTION".

2 Press [ENTER] repeatedly to select "OFF".

3 Press [SET-UP] to exit the menu.

CHANNEL SET UP

Channel presetting is necessary at the start or in case you moved the TV to a different area.



AUTO CHANNEL PROGRAMMING

1 Press [SET-UP].

Use [▲ / ▼] to point to "CHANNEL SET UP", then press [ENTER].

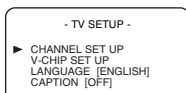

2 Use [▲ / ▼] to point to "AUTO CH PROGRAMMING", then press [ENTER].

The tuner scans and memorizes all the active channels in your area.

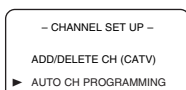

3 When the scanning is completed, the lowest memorized channel is displayed.

If "NO TV SIGNALS" appears on the TV screen, check the antenna connection and try again.

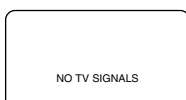
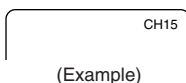

NOTES:

- The unit may recognize CATV channels to be TV channels if reception condition is poor. In this case, check the antenna connection and try "AUTO CH PROGRAMMING" again.
- Auto channel programming is **NOT** necessary when connected to a cable box or satellite box. Just select the channel for cable box or satellite input (ex. CH3 or CH4) on the unit, then select your desired channel on the cable box or satellite box.

ADDING/DELETING CHANNELS

You can add channels that was not memorized due to the bad reception status and also delete channels you no longer receive or seldom watch.

1 Press [SET-UP].

Use [▲ / ▼] to point to "CHANNEL SET UP", then press [ENTER].



2 Use [▲ / ▼] to point to "ADD/DELETE CH", then press [ENTER].

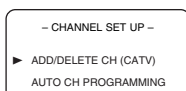

3 Use the Number buttons or [CH. ▲ / ▼] to select your desired channel number. (You can also use [▲ / ▼] to enter it.)

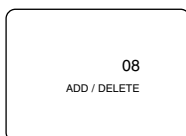

(Example: CH8)

- Refer to page 9 on how to use the Number buttons.

4 Press [ENTER] repeatedly. The channel number changes to red (deleted) or blue (added) every time you press the button.

- To delete or add another channel, repeat steps 3 to 4.

5 Press [SET-UP] to exit the menu.

NOTE:

- To confirm that channel(s) has (have) been deleted or added, select it (them) using [CH. ▲ / ▼].

ON-SCREEN MENU LANGUAGE

You can select the language of on-screen menu among English, Spanish and French.



1 Press [SET-UP].

Use [▲ / ▼] to point to "LANGUAGE".

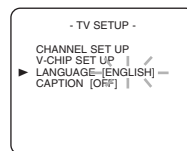

2 Press [ENTER] repeatedly to select "ENGLISH", "ESPAÑOL" or "FRANÇAIS".

3 Press [SET-UP] to exit the menu.

NOTES:

- This function effects only the language on the screen menu and not the audio source.
- If for some reason the menu is already in Spanish or French, press [SET-UP], using [▲ / ▼] point to "IDIOMA [ESPAÑOL]" or "LANGAGE [FRANÇAIS]", then press [ENTER] repeatedly to select desired language, then press [SET-UP].

V-CHIP SET UP

This feature enables parents to prevent their children from watching inappropriate material on TV. When you try to access a blocked program, "PROTECTED PROGRAM by ..." message appears on the TV screen.



NOTE:

- To change the rating, the TV must be turned to an unprotected program. If the screen on the right is displayed, change the channel to a station that is not protected.

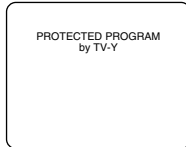

1 Press [SET-UP].

Use [▲ / ▼] to select "V-CHIP SET UP", then press [ENTER].

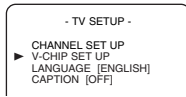

2 Use the Number buttons to enter the access code.

- For the first time set-up or in the event the unit has lost power, enter the default code of 0000.

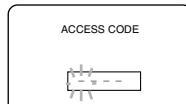

3 Use [▲ / ▼] to select an item, then press [ENTER]. Refer to the pages below to set up each item.

- TV RATING : P12 **A**
- MPAA RATING : P13 **B**
- CHANGE CODE: P13 **C**

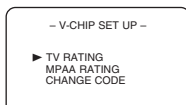

A TV RATING SET UP

4 Use [▲ / ▼] to select a rating that you wish to block.

Press [ENTER] repeatedly to set it to "BLOCK" or "VIEW".

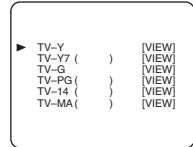

Selection	Rating Category Explanations
TV-Y	Appropriate for all children
TV-Y7	Appropriate for children seven and older
TV-G	General Audience
TV-PG	Parental Guidance suggested
TV-14	Unsuitable for children under 14
TV-MA	Mature audience only

NOTES:

- When you select a rating and set it to "BLOCK", the higher ratings will be blocked automatically. The lower ratings will be available for viewing.
- When you set the lowest rating to "VIEW", all other ratings will be automatically available for viewing.

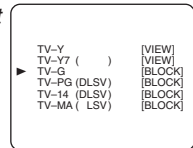

5 The TV-Y7, TV-PG, TV-14 and TV-MA ratings have the option of sub rating categories.

Use [▲ / ▼] to select a rating with sub-ratings, then press [ENTER] twice.

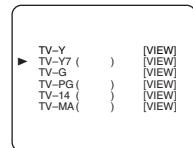

6 Use [▲ / ▼] to select a sub-rating, then press [ENTER] to set it to "BLOCK" or "VIEW".

NOTE:

- The blocked sub-ratings will appear next to the rating category in the "TV RATING" menu.

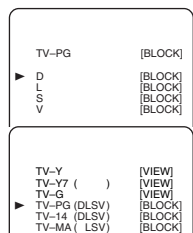

Selection	Rating Category Explanations
TV-Y7	
FV	Fantasy Violence
TV-PG, TV-14, TV-MA	
D	Suggestive Dialog (TV-PG, TV-14 only)
L	Coarse Language
S	Sexual Situation
V	Violence

7 Press [SET-UP] to exit the menu.

B MPAA RATING SET UP

- 4 Use [▲ / ▼] to point to your desired item, then press [ENTER] to select "BLOCK" or "VIEW".

G	[VIEW]
PG	[VIEW]
PG-13	[VIEW]
R	[BLOCK]
NC-17	[BLOCK]
X	[BLOCK]

Selection	Rating Category Explanations
G	General Audience
PG	Parental Guidance suggested.
PG-13	Unsuitable for children under 13
R	Restricted; under 17 requires accompanying parent or adult guardian
NC-17	No one under 17 admitted
X	Mature audience only

- 5 Press [SET-UP] to exit the menu.

C CHANGE ACCESS CODE

- 4 Use the **Number buttons** to enter your desired access code in the "NEW CODE", then enter the same code in the "CONFIRM CODE". When completed, the menu will return to "V-CHIP SET UP".

NEW CODE	<input type="text" value="X X X X"/>
CONFIRM CODE	<input type="text" value="X X X X"/>

- 5 Press [SET-UP] to exit the menu.

NOTE:

- Your personal access code will be erased and will return to the default (0000) when a power failure occurs or when you turn off the power using a wall switch. If you forget the code, unplug the power cord for 10 seconds to restore the access code to 0000.

DVD SECTION

ABOUT THE DISCS

PLAYABLE DISCS

Playable discs	Mark (logo)	Region code	Recorded signals	Disc size	Disc types
DVD-Video *1,2,4,6,10,11			Digital video (MPEG2)	12 cm or 8 cm	<p>Example: Title 1 (Chapter 1, Chapter 2, Chapter 3, Chapter 4), Title 2 (Chapter 1, Chapter 2)</p>
DVD-RW DVD-R *1,3,4,5,6,7,9,10		-			
DVD+RW DVD+R *1,3,4,5,6,8,9,10		-			
Audio CD *4,6,10		-	Digital audio	12 cm or 8 cm	<p>Example: Track 1, Track 2, Track 3, Track 4, Track 5, Track 6</p>
CD-RW CD-R *4,5,6,9,10					

DVD is a trademark of DVD Format/Logo Licensing Corporation.

If you cannot play back a disc which bears one of the marks above, check the following notes.

- *1: This unit conforms to the NTSC color system. Discs recorded in other color systems such as PAL cannot be played back.
- *2: Certain DVD-Video discs do not operate as described in this manual due to the intentions of the disc's producers.
- *3: Discs recorded in the VR (Video Recording) format cannot be played back.
- *4: Scratched or stained discs may not be played back.
- *5: Some discs cannot be played back because of incompatible recording conditions, characteristics of the recorder or special properties of discs.
- *6: You can play back discs which bear the marks above. If you use nonstandardized discs, this unit may not play them back. Even if they are played back, the sound or video quality will be compromised.
- *7: You may play back the unfinalized DVD-R/RW disc recorded in the video format on our brand's DVD recorder. However, depending on the recording status of a disc, the disc may not be played back at all or normally (the picture or sound may not be smooth, etc.). In this case, you need to finalize the disc with the DVD recorder. Refer to the manual accompanying the DVD recorder.
- *8: Only the discs recorded in the video format and finalized can be played back. Unfinalized discs cannot be played back. Depending on the recording status of a disc, the disc may not be played back at all or normally (the picture or sound may not be smooth, etc.).
- *9: If there is too much recording space left on a disc (the used portion is less than 55mm across), it may not play back properly.
- *10: Do not glue paper or put stickers on to the disc. These may damage the disc and the unit may not read it correctly.
- *11: The number inside the symbol refers to a region of the world and a disc encoded in a specific region format can only be played back on unit with the same region code.

UNPLAYABLE DISCS

- **NEVER play back the following discs. Otherwise, malfunction may result!**
DVD-RAM / CD-i / Photo CD / Video CD / DVD-Audio / DVD with region codes other than 1 or ALL / DTS-CD / DVD-ROM for personal computers / CD-ROM for personal computers / MP3
- **The sound MAY NOT be heard:** Super Audio CD

NOTE:

Only the sound recorded on the normal CD layer can be delivered. The sound recorded on the high density Super Audio CD layer cannot be delivered.

- **Any other discs without compatibility indications**

PLAYING A DISC

BASIC PLAYBACK

1 Press [POWER] to turn on the unit.



2 Press [OPEN/CLOSE ▲].

3 Place the disc in the tray, with the label facing up.

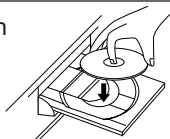

4 Press [PLAY ►].

- The tray will close automatically and playback will start. When you play back a DVD which features a title menu, it may appear on the screen.

NOTES:

- Closing the disc tray manually or by pressing [OPEN/CLOSE ▲] also starts playback.
- With DVDs that use titles for playback program signals, playback may start from the second title or it may skip these titles.

5 To freeze the picture, press [PAUSE ■] during playback.

NOTE:

- The sound will be muted in pause mode.

6 Press [STOP ■] to stop playback temporarily.

- Press [PLAY ►] to resume the playback.
- To cancel resume and stop the disc, [STOP ■] again.

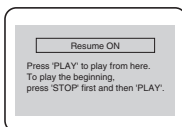

NOTES:

- The resume information stays on even if the unit is turned off.
- A "prohibited icon" may appear at the top-right on the TV screen during operation. This means that the operation is not available on the disc.

STEP BY STEP PLAYBACK

• During playback, press [PAUSE ■]. You can advance the picture frame by frame by pressing [PAUSE ■] repeatedly.



• To return to normal playback, press [PLAY ►].

FAST FORWARD / FAST REVERSE

• During playback, press [FWD ►►] for fast forward or [REV ◀◀] for fast reverse.



• Every time you press the button, playback speeds up and the level of the speed appears on the screen.

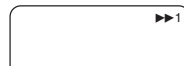

NOTES:

- For DVDs, fast forward/reverse speed is different depending on the disc. Approximate speed is 1 (x2), 2 (x8), 3 (x20), 4 (x50) and 5 (x100).
- For Audio CDs approximate speed is 1 (x2), 2 (x8) and 3 (x30).

• To return to normal playback, press [PLAY ►].

SLOW FORWARD / SLOW REVERSE

• During playback, press [PAUSE ■].



• Press [FWD ►►] for slow forward or [REV ◀◀] for slow reverse.

• Every time you press the button, playback is slowed down and the level of the speed appears on the screen.



NOTE:

- Slow forward / reverse speed varies with the disc. Approximate speed is 1 (1/16), 2 (1/8) and 3 (1/2).

• To return to normal playback, press [PLAY ►].

DISC MENU / TITLE MENU

DVD may contain menus to navigate the disc and access special features.



1 Press [DISC MENU] or [TITLE].

- The DVD main menu / the title menu will appear.
- You can call up the menu even during playback.

2 Use [▲ / ▼ / ◀ / ▶] to select an item, and press [ENTER].

NOTES:

- If disc menu is available on the disc, audio language, subtitle options, chapters for the title and other options will appear for selection.
- Contents of menu and corresponding menu operations may vary between discs. Refer to the manual accompanying the disc for details.

SPECIAL PLAYBACK FUNCTIONS & SETTINGS

FUNCTION TABLE

Setting menu switches as below every time you press **[MODE]** during playback.



See the reference page for how to set each menu. Some functions are not available in specific modes, but this is not a malfunction.

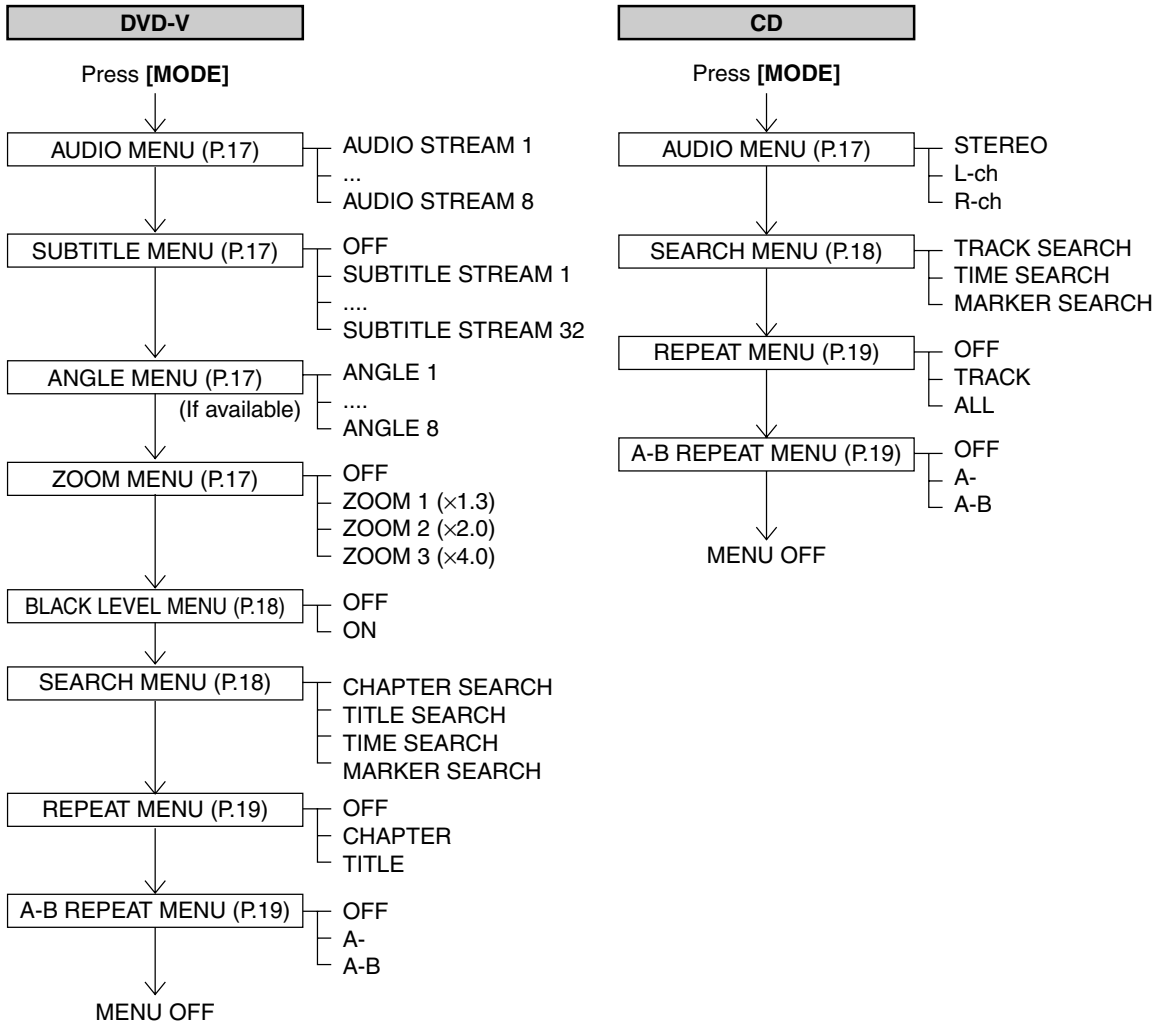

AUDIO MENU

AUDIO LANGUAGE



You can select audio language during DVD playback (if multi languages are available).

1 Press [MODE] during playback.

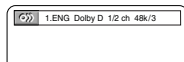

2 Use [▲ / ▼] to select your desired language.

NOTES:

• This function may not work on some DVDs with multiple audio languages. In this case, set it on the disc menu. (Operation varies depending on discs. Refer to the manual of the disc.)

• When "NOT AVAILABLE" appears on the TV screen, it means this function is not available on the disc.



3 Press [RETURN] to exit the menu.

STEREO SOUND MODE



You can select sound output mode during CD playback.

1 Press [MODE] during playback.

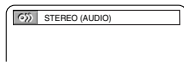

2 Use [▲ / ▼] to select the sound mode.

• STEREO: mixed sound of left and right channels

L-ch: left channel sound only

R-ch: right channel sound only

3 Press [RETURN] to exit the menu.

SUBTITLE LANGUAGE

You can select a language for subtitles during DVD playback (if available).



1 During playback, press [MODE] repeatedly until SUBTITLE menu appears.



2 Use [▲ / ▼] to select your desired subtitle language. To cancel subtitles, select "OFF".

3 Press [RETURN] to exit the menu.

NOTES:

• This function may not work on some DVDs with multiple subtitle languages. In this case, set it on the disc menu. (Operation varies depending on discs. Refer to the manual of the disc.)

• If the selected language does not have 3-letter code, "----" will be displayed on the screen. (Refer to LANGUAGE CODE LIST on page 27.)

ANGLE MENU

Some DVD discs contain scenes which have been shot from various angles and you can change them as you like.



1 During playback, press [MODE] repeatedly until ANGLE menu appears.

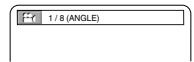

2 Use [▲ / ▼] to select your desired angle.

3 Press [RETURN] to exit the menu.

NOTE:

• If multiple angle function is not available, this menu does not appear on the screen.

ZOOM

The Zoom function allows you to enlarge the video image and to pan through the enlarged image.



1 During playback, press [MODE] repeatedly until ZOOM menu appears.

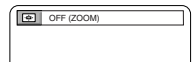

2 Press [ENTER] repeatedly to select the required zoom factor.

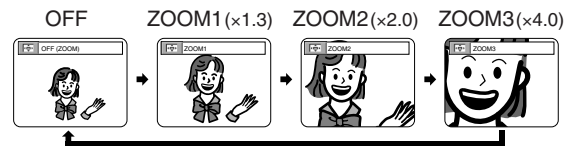

3 Use [▲ / ▼ / ◀ / ▶] to move the zoomed picture across the screen.

4 Press [RETURN] to exit.

- The zoomed position guide appears on the right corner of the TV screen in the zoom mode.



NOTES:

- Zooming function does not work while disc menu is shown.
- Zooming function is not available on some discs.
- It may take several seconds to slide the zoomed picture.
- The picture may be distorted if you operate other functions (ex. pause, fast forward etc.) repeatedly in the zoom mode.
- To cancel the zoom mode, repeat steps 1-2 and press [ENTER] until "OFF" appears.

BLACK LEVEL MENU

You can adjust the Black Level to make the black parts of the picture brighter. 

- 1 During playback, press **[MODE]** repeatedly until BLACK LEVEL menu appears.

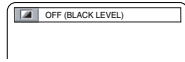

- 2 Use **[▲ / ▼]** to select "ON" or "OFF".
 - ON: Makes the dark parts brighter.
 - OFF: Shows the original picture as recorded. (Initial setting)

- 3 Press **[RETURN]** to exit the menu.

NOTE:

- The setting will be saved even if the unit is turned off.

SEARCH MENU

You can begin playback at a specific track, title, chapter or from a specific point on a disc.

TRACK SEARCH

- 1 During playback, press **[MODE]** repeatedly until SEARCH menu appears.

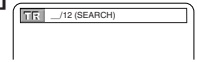

- 2 Within 60 seconds, use **the Number buttons** to select the desired track number. Playback will start from the selected track.

NOTES:

- For single digit press **[0]** first, if the total track of the disc is 10 tracks or more.
- You can also skip tracks by using **[SKIP ◀◀ / ▶▶]**, or entering the desired track number with **the Number buttons**.

- 3 Press **[RETURN]** to exit the menu.

CHAPTER SEARCH

- 1 During playback, press **[MODE]** repeatedly until SEARCH menu appears.

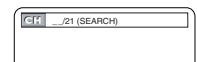

- 2 Use **the Number buttons** to enter the desired chapter number. Playback will start at the selected chapter.
 - Press **[CLEAR]** to erase the incorrect input.
 - For single digit press **[0]** first, if the total number of chapters of the disc is 10 or more.

- 3 Press **[RETURN]** to exit the menu.

NOTE:

- You can also skip chapters by using **[SKIP ◀◀ / ▶▶]**, or entering the desired chapter number with **the Number buttons**.

TITLE SEARCH

- 1 During playback, press **[MODE]** repeatedly until SEARCH menu appears.

- 2 Use **[▲ / ▼]** to display TITLE SEARCH menu.



- 3 Use **the Number buttons** to enter the desired title number. Playback will start at the selected title.
 - Press **[CLEAR]** to erase the incorrect input.
 - For single digit press **[0]** first, if the total number of titles of the disc is 10 or more.

- 4 Press **[RETURN]** to exit the menu.

TIME SEARCH

1 During playback, press **[MODE]** repeatedly until SEARCH menu appears.

2 Use **[▲ / ▼]** repeatedly to display TIME SEARCH menu.



3 Within 60 seconds, use **the Number buttons** to enter a desired disc time. Playback will start at the specified time.

- Press **[CLEAR]** to erase the incorrect input.
- When there is no need to enter a number, "0" appears automatically.

4 Press **[RETURN]** to exit.

MARKER SEARCH

You can set markers to memorize your favorite places on a disc.

1 During playback, press **[MODE]** repeatedly until SEARCH menu appears.

2 Use **[▲ / ▼]** repeatedly to display MARKER SEARCH menu.



3 Use **[◀ / ▶]** to select a marker number among 1 to 10.

4 When the track (or title) reaches your desired point, press **[ENTER]** to set a marker.

- The track (or title) number and elapsed playing time will appear on the TV screen.

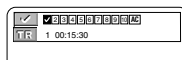

5 You can play from the desired point by selecting the marker number by using **[◀ / ▶]** and then pressing **[ENTER]**.

6 To clear a marker, select the marker number and press **[CLEAR]**. To clear all markers at once, select "AC" with **[◀ / ▶]** and press **[ENTER]**.

NOTE:

- The following operation will also erase all markers:
 - Opening the disc tray
 - Turning off the power
 - Pressing **[SELECT]**

7 Press **[RETURN]** to exit the menu.

REPEAT PLAYBACK

REPEAT TRACK

1 During playback, press **[MODE]** repeatedly until REPEAT menu appears.

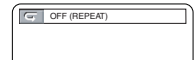

2 Use **[▲ / ▼]** to select your desired repeat mode.

- OFF: Repeat function off
- TRACK: Current track repeat
- ALL: All track repeat

NOTE:

- Repeat Track setting will be cleared when moving to other track.

3 Press **[RETURN]** to exit the menu.

REPEAT TITLE / CHAPTER

1 During playback, press **[MODE]** repeatedly until REPEAT menu appears.

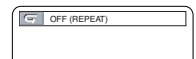

2 Use **[▲ / ▼]** to select your desired repeat mode.

- OFF: Repeat function off
- CHAPTER: Current chapter repeat
- TITLE: Current title repeat

NOTE:

- Repeat Title/Chapter is not available in some scenes.
- The REPEAT setting will be cleared when moving to other title or chapter.

3 Press **[RETURN]** to exit the menu.

REPEAT A-B

1 Press **[MODE]** repeatedly until A-B REPEAT menu appears.

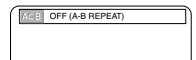

2 Press **[ENTER]** at your desired starting point (A). To cancel it, press **[CLEAR]**.

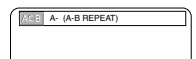

3 Press **[ENTER]** again at your desired ending point (B). The repeat sequence begins.

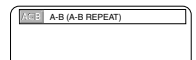

4 To exit the sequence, follow step **1** and press **[ENTER]** repeatedly until "OFF" appears and press **[RETURN]** to exit the menu.

NOTES:

- The A-B repeat section can be set only within the current title (for DVDs) or current track (for Audio CDs).
- A-B repeat is not available with some scenes in DVD.
- A-B repeat playback is not available during other repeat playback.

SPECIAL PLAYBACK FUNCTIONS & SETTINGS

PROGRAMMED PLAYBACK

You can determine the playing order of tracks. 

1 In the stop mode, press [MODE].

- The PROGRAM screen appears.

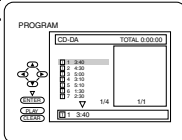

2 Use [▲ / ▼] to select a track, then press [ENTER].

NOTES:

- Up to 99 tracks can be entered.
- Press [CLEAR] to erase the most recently entered track.
- If you enter more than 8 tracks, you can change pages of the program list with [SKIP ◀◀ / ▶▶].
- To erase all tracks in the program at once, select "ALL CLEAR" at the bottom of the track list.

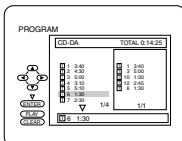

3 Repeat step 2 until you select all the tracks you want to play in the program.

4 Press [PLAY ▶] to play the programmed tracks.

5 Press [STOP ■] to temporarily stop the playback. You can resume the playback by pressing [PLAY ▶].

Press [STOP ■] twice to cancel the programmed playback.

NOTE:

- REPEAT setting is available during programmed playback. (Refer to "REPEAT TRACK" on page 19.)

RANDOM PLAYBACK

This function shuffles the playing order of tracks. 

1 In the stop mode, press [MODE] twice.

- The RANDOM screen appears.

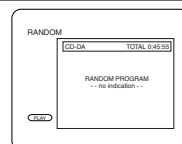

2 Press [PLAY ▶] to start random playback.

NOTE:

- REPEAT setting is available during random playback. (Refer to "REPEAT TRACK" on page 19.)

3 Press [STOP ■] to stop random playback.

ON-SCREEN INFORMATION

You can check the information about the current disc by pressing [DISPLAY].



For DVD-Videos

1 Press [DISPLAY] during playback to show current Chapter.

- The elapsed and remaining playing time of the current chapter will be displayed.



2 Press [DISPLAY] again to show current Title.

- The elapsed and remaining playing time of the current title will be displayed.

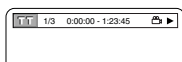

3 Press [DISPLAY] again.

- The bit rate and the current repeat setting will be displayed.
- If you are playing a dual layered disc, the layer number will also be displayed (L0: Layer 0 is playing. L1: Layer 1 is playing).



4 Press [DISPLAY] again to exit.

For Audio CDs

1 Press [DISPLAY] during playback to show the current Track.

- The elapsed and remaining playing time of the current track will be displayed.

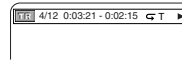

2 Press [DISPLAY] again to show current Total Track.

- The elapsed and remaining playing time of the total track will be displayed.

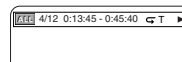

When in the PROGRAM or RANDOM mode.

3 Press [DISPLAY] again to exit.

CHANGING THE DVD SET UP ITEMS

You can change the DVD player's settings by pressing [SET-UP] in DVD mode. The set up items are shown in the diagram below.

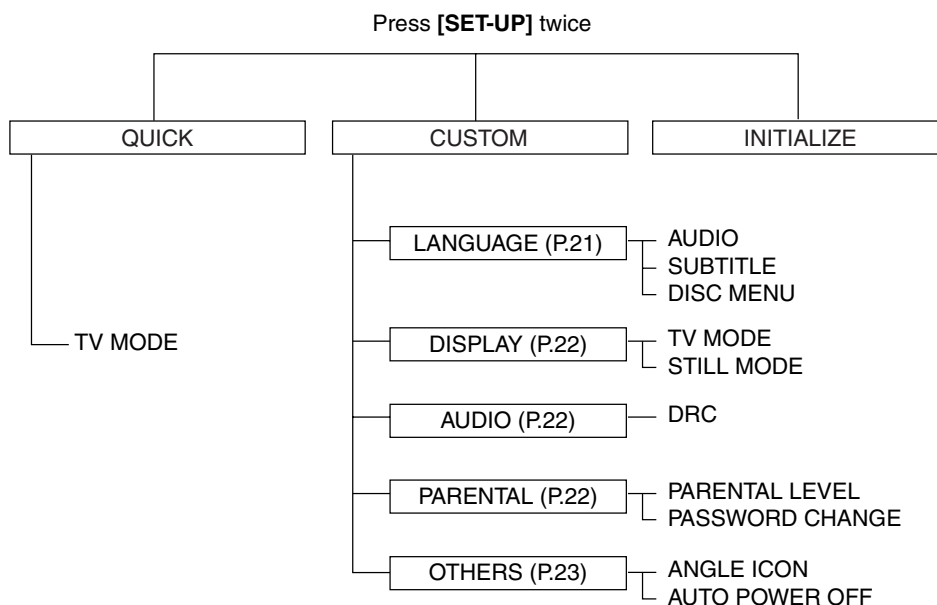

CUSTOM MENU

1 In the stop mode, press [SET-UP] twice to display the DVD SETUP menu.

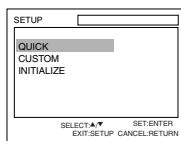

NOTES:

- Pressing [SET-UP] once will show TV SETUP menu partly.
- If the menu does not appear, press [STOP ■] first. Make sure the unit is in DVD mode before setting.

2 Use [▲ / ▼] to select "CUSTOM", then press [ENTER].

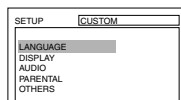

3 Use [▲ / ▼] to select the desired item, then press [ENTER].

Refer to the pages below for continuation to set up each item.

- LANGUAGE setting: P21 **A**
- DISPLAY setting: P22 **B**
- AUDIO setting: P22 **C**
- PARENTAL setting: P22 **D**
- OTHERS setting: P23 **E**

A LANGUAGE SETTING



4 Use [▲ / ▼] to select the desired item, then press [ENTER].

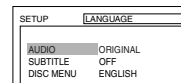

- AUDIO: Sets the audio language.
- SUBTITLE: Sets the subtitle language.
- DISC MENU: Sets the language for DVD menu.

5 Use [▲ / ▼] to select your desired language from the list, then press [ENTER].

6 Press [SET-UP] to exit the menu.

NOTES:

- If your desired language is not on the list, select "OTHER" and enter the code of the language. (Refer to "LANGUAGE CODE LIST" on page 27.)
- This feature may not be valid due to default setting of the disc. In this case, press [MODE] to select the language. (Refer to "AUDIO MENU" on page 17.)
- If you select a language that is not supported by the disc, subtitle will be "OFF" automatically and the default language of the disc will be selected.
- To change the language for the on-screen menus, call up the TV SETUP menu by pressing [SET-UP] once and set the language. (Refer to "ON-SCREEN MENU LANGUAGE" on page 11.)

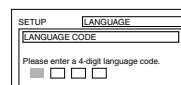

CHANGING THE DVD SET UP ITEMS

B DISPLAY SETTING

4 Use **[▲ / ▼]** to select an item, then press **[ENTER]**.

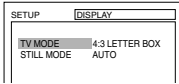

• **TV MODE:** **QUICK**

You can change certain aspects of the DVD display screens and on-screen messages on the TV screen.

- **4:3 LETTER BOX (default):**
To show black bars on top and bottom of the screen.
- **4:3 PAN & SCAN:**
To show a full height picture with both sides trimmed.

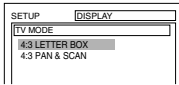

NOTE:

• You can access this setting directly by selecting "QUICK" at step 2 on page 21.

• **STILL MODE:**

This function allows you to adjust picture resolution and quality in the still mode.

- **AUTO (default):**
Automatically select the best resolution setting (FRAME or FIELD) based on the data characteristics of the pictures.
- **FIELD:**
Select "FIELD" when the pictures are still unstable even if "AUTO" is selected. FIELD stabilizes the pictures, although the picture quality may become coarse due to the limited amount of data.
- **FRAME:**
Select "FRAME" to display relatively motionless pictures in higher resolution. FRAME improves the picture quality, although it may unstabilize the pictures due to simultaneous output of two field data.

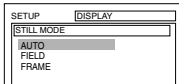

5 Press **[SET-UP]** to exit the menu.

C AUDIO SETTING

Choose the appropriate Audio settings for your equipment as it only affects during the playback of DVD discs.

4 Press **[ENTER]** repeatedly until your desired setting appears.

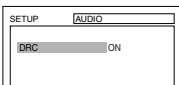

- **DRC (Dynamic Range Control):**
 - **ON :** To compress the range of soft to loud sound. (default)
 - **OFF :** Output the original sound.

5 Press **[SET-UP]** to exit the menu.

D PARENTAL SETTING

This feature allows you to set the rating level of your DVD discs. Playback will stop if the disc ratings exceed the level you set.

PARENTAL LEVEL

4 Enter four-digit password with the **Number buttons**, then press **[ENTER]**.

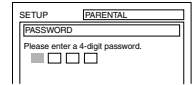

NOTE:

• Enter any 4 digits (except for 4737) to set the password for the first time, and record it for your memory.

5 Use **[▲ / ▼]** to select "PARENTAL LEVEL", then press **[ENTER]**.

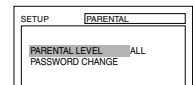

6 Use **[▲ / ▼]** to select the desired level, then press **[ENTER]**.

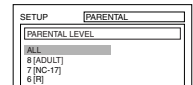

7 Press **[SET-UP]** to exit the menu.

CONTROL LEVELS

- **ALL:** All parental locks are cancelled.
- **8 [ADULT]:** DVD software of any grade (adult/general/children) can be played back.
- **7 to 2:** Only DVD software intended for general use and children can be played back.
- **1 [KID SAFE]:** Only DVD software intended for children can be played back, with those intended for adult and general use prohibited.

NOTE:

• With some DVDs, it may be difficult to find if they are compatible with parental lock. Be sure to check if the parental lock function operates in the way that you have set.

PASSWORD CHANGE

- 4** Enter current password with the **Number buttons**, then press **[ENTER]**.

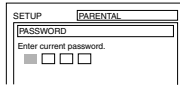

- 5** Use **[▲ / ▼]** to select "PASSWORD CHANGE", then press **[ENTER]**.

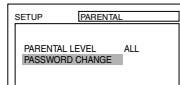

- 6** Enter four-digit password with the **Number buttons**, then press **[ENTER]**.

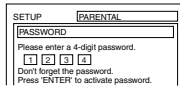

- 7** Press **[SET-UP]** to exit the menu.

NOTE:

- If you forget the current password, enter 4737 first, then enter your new password.
- The former password will be cleared and parental level will be set to "ALL" (default).

E OTHER SETTING

- 4** Use **[▲ / ▼]** to select an item, then press **[ENTER]** repeatedly to set the feature "ON" or "OFF".

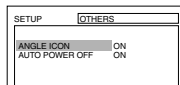

- **ANGLE ICON:**
 - ON: To show the angle icon when multiple camera angles are available during DVD playback. (default)
 - OFF: To keep angle icon from the display.
- **AUTO POWER OFF:**
 - ON: To activate screen saver program and turn off the unit automatically. (default)
 - OFF: To deactivate Auto Power Off function.

NOTE:

- The screen saver program starts when there is no input from the unit for 5 minutes in the stop mode. After the screen saver program is activated for 15 minutes, the power is automatically turned off.

- 5** Press **[SET-UP]** to exit the menu.

INITIALIZE

This allows you to return all items of SETUP menu (except for **PARENTAL setting** and **menu language**) to their default settings. 

- 1** In the stop mode, press **[SET-UP]** twice to display the DVD SETUP menu.

- 2** Use **[▲ / ▼]** to select "INITIALIZE", then press **[ENTER]**.

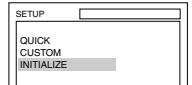

- 3** Use **[▲ / ▼]** to select "YES", then press **[ENTER]** twice.
- To cancel the initialization, select "NO".

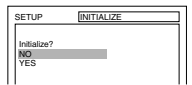

- 4** Press **[SET-UP]** to exit the menu.

TROUBLESHOOTING GUIDE

If the unit does not perform properly when operated as instructed in this Owner's Manual, check the following guide for the possible remedy of a problem before contacting the Customer Service. Sometimes a performance problem can be easily solved by checking seemingly apparent but often overlooked possibilities. It could save your time and money.

	SYMPTOM	POSSIBLE REMEDY	PAGE
General	No power	<ul style="list-style-type: none"> • Make sure the power plug is connected to an AC outlet. • (In case of power failure) Check the breaker. 	9 --
	No operation by remote control	<ul style="list-style-type: none"> • Check if the batteries are weak or inserted incorrectly. Replace weak batteries and insert with their polarities (+/- signs) as indicated. • Aim the remote control at the remote sensor and operate within 23 feet (7 m) of the unit. • Remove all obstacles to clear the path of the infrared signal. • Check the infrared signal output. • Select the correct mode to operate by pressing [SELECT]. • The operable range from the unit is 10 feet (3 m) within 15°. 	7 -- -- 26 9 --
TV mode	Poor or no picture	<ul style="list-style-type: none"> • Check if antenna or cable is connected properly • Check for the broken pin or wire of antenna cable. • Check for source of reception disturbance. • Press [SELECT] to select the correct mode. • Perform channel scanning to memorize available TV channels. • Try another channel. If OK, then possible station problem. • Adjust picture control (COLOR/CONTRAST/BRIGHT etc.). • Check for magnetism from nearby appliances and try degaussing. 	6 -- -- 9 11 -- 10 --
	Poor or no sound	<ul style="list-style-type: none"> • Adjust volume control using [VOL. Δ / ▽]. • Try another channel. If OK, then possible station problem. 	-- --
	Misspelling in captions	<ul style="list-style-type: none"> • Error committed by the closed captioning production company. • Possible in a live broadcast. Not in case of a prerecorded program. 	-- --
	Text is not shown in its entirety or a delay occurs from what is being said	<ul style="list-style-type: none"> • A few seconds of delay is common for live broadcast. If a dialogue exceeds the display capacity (220 words per minute), selective editing is used so that the captions remain up-to-date with the current TV screen dialogue. 	--
	Captions scrambled with white boxes	<ul style="list-style-type: none"> • Caused by interferences of building, power lines, thunderstorms, etc. 	--
	No captions in a program which must contain closed caption	<ul style="list-style-type: none"> • The broadcast may use a time compression process to speed up the program. The decoder cannot read the compressed information and captions will be lost. 	--
	No captions in a pre-recorded videotape with indicated closed captions included	<ul style="list-style-type: none"> • Possibility of a illegal copy or an erroneous copying process accidentally performed by the fabricator. 	--
	Black box in the TV screen	<ul style="list-style-type: none"> • You are in TEXT mode. Select CAPTION mode or "OFF". 	10

	SYMPTOM	POSSIBLE REMEDY	PAGE
DVD mode	No picture	<ul style="list-style-type: none"> This unit cannot play DVD-RAM/CD-i/Photo CD/Video CD/DVD with region codes other than "1" and "ALL". 	14
	Disc cannot be played	<ul style="list-style-type: none"> Clean the disc. Place the disc correctly, with the label side up. Cancel the parental setting or change the control level. 	26
			15
			22
	No sound	<ul style="list-style-type: none"> Correct the audio output settings. 	22
	No DTS audio is output	<ul style="list-style-type: none"> This unit does not support DTS audio. This is not a malfunction. 	--
	Distorted picture	<ul style="list-style-type: none"> During the playback of a 2-layered disc, pictures may stop for a moment. This happens while the 1st layer is being switched to the 2nd layer. This is not a malfunction. This happens right after fast forwarding or rewinding. 	--
			--
	Audio or subtitle language does not match the setting	<ul style="list-style-type: none"> The selected language is not available for audio or subtitle on the DVD. 	21 --
	The camera angle cannot be changed	<ul style="list-style-type: none"> The DVD does not contain sequences recorded from different camera angles. 	17
Audio or subtitle language cannot be changed	<ul style="list-style-type: none"> The DVD does not contain audio source or subtitles in the selected language. 	21	
"Prohibited icon" appears on the screen	<ul style="list-style-type: none"> That operation is not available by the unit or the disc. 	15	
CD/DVD sound dropout No CD/DVD reproduction DVD picture poor	<ul style="list-style-type: none"> Scratched disc. Replace with an unscratched one. 	--	

NOTES:

- Some functions are not available in specific modes, but this is not a malfunction. Read the description in this Owner's Manual for details on correct operations.
- Playback from a desired track and random playback are not available during playback.

MAINTENANCE

DEGAUSSING

A degaussing circuit in this unit clears up color errors on the TV screen. Color errors occur when there is any excess magnetism close to the unit. This circuit is designed to operate once when the unit is first plugged in. **If you see minor color errors on the screen, unplug the unit for approximately 30 minutes.** When you plug the unit again, the degaussing circuit will operate to clear errors. Take this step any time the TV screen is accidentally magnetized or when you move the unit.

IF THE LASER OPTICAL PICKUP UNIT IS DIRTY

- If the unit still does not perform properly when it is operated, while referring to the relevant sections and to "TROUBLESHOOTING GUIDE" in this Owner's Manual, the laser optical pickup unit may be dirty. Consult your dealer or an Authorized Service Center for inspection and cleaning of the laser optical pickup unit.

CABINET CLEANING

- Wipe the front panel and other exterior surfaces of the unit with a soft cloth immersed in lukewarm water and wrung dry.
- Never use a solvent or alcohol. Do not spray insecticide liquid near the unit. Such chemicals may cause damage and discoloration to the exposed surfaces.

SERVICING

- Should your unit become inoperative, do not try to correct the problem by yourself. There are no user-serviceable parts inside. Turn off, unplug the power cord and **please call our help line mentioned on the front page**, to locate an Authorized Service Center.

IR SIGNAL CHECK

Use the AM radio or the digital camera to check if the remote control properly sends out the infrared signal. It will help to define the cause of malfunction.

Using AM radio

- Tune the AM radio to no broadcasting band. Press any button on remote control toward the radio. If the radio receives the signal from remote control properly, the sound will flutter.



Using digital camera

(including built-in camera of cellular phone)

- Press and hold any button on remote control toward a digital camera. The remote control is working if you confirm infrared light through the digital camera.



DISC HANDLING

- Handle the discs so that fingerprints and dust do not adhere to the surfaces of the discs.



- Always store the disc in its protective case when it is not used.
- To clean-off, use a soft cloth.
- Do not use a hard cloth since this will mar the disc.
- Wipe the disc in a straight line from center to edge.
- Never wipe with a circular motion.
- Do not use detergent or abrasive cleaning agents.



APPENDIX

CABLE CHANNEL DESIGNATIONS

If you subscribe to cable TV, the channels are displayed as 1-125. Cable companies often designate channels with letters or letter-number combinations. Please check with your local cable company. The following is a chart of common cable channel designations.

CATV channel	5A	2	3	4	5	6	7	8	9	10	11	12	13	A	B
TV Display	1	2	3	4	5	6	7	8	9	10	11	12	13	14	15
CATV channel	C	D	E	F	G	H	I	J	K	L	M	N	O	P	Q
TV Display	16	17	18	19	20	21	22	23	24	25	26	27	28	29	30
CATV channel	R	S	T	U	V	W	W+1	W+2	W+3	W+4	W+5	W+6	W+7	W+8	W+9
TV Display	31	32	33	34	35	36	37	38	39	40	41	42	43	44	45
CATV channel	W+10	W+11	W+12	W+13	W+14	W+15	W+16	W+17	W+18	W+19	W+20	W+21	W+22	W+23	W+24
TV Display	46	47	48	49	50	51	52	53	54	55	56	57	58	59	60
CATV channel	W+25	W+26	W+27	W+28	W+29	W+30	W+31	W+32	W+33	W+34	W+35	W+36	W+37	W+38	W+39
TV Display	61	62	63	64	65	66	67	68	69	70	71	72	73	74	75
CATV channel	W+40	W+41	W+42	W+43	W+44	W+45	W+46	W+47	W+48	W+49	W+50	W+51	W+52	W+53	W+54
TV Display	76	77	78	79	80	81	82	83	84	85	86	87	88	89	90
CATV channel	W+55	W+56	W+57	W+58	A-5	A-4	A-3	A-2	A-1	W+59	W+60	W+61	W+62	W+63	W+64
TV Display	91	92	93	94	95	96	97	98	99	100	101	102	103	104	105
CATV channel	W+65	W+66	W+67	W+68	W+69	W+70	W+71	W+72	W+73	W+74	W+75	W+76	W+77	W+78	W+79
TV Display	106	107	108	109	110	111	112	113	114	115	116	117	118	119	120
CATV channel	W+80	W+81	W+82	W+83	W+84										
TV Display	121	122	123	124	125										

LANGUAGE CODE LIST

Language	Code	Language	Code	Language	Code	Language	Code		
A-B				German [GER]	5051	Somali	6561		
Abkhazian	4748	Greek [GRE]	5158	Nauru	6047	Spanish [SPA]	5165		
Afar	4747	Greenlandic	5758	Nepali	6051	Sundanese	6567		
Afrikaans	4752	Guarani	5360	Norwegian [NOR]	6061	Swahili	6569		
Albanian	6563	Gujarati	5367	O-R				Swedish [SWE]	6568
Amharic	4759	Hausa	5447	Occitan	6149	T			
Arabic	4764	Hebrew	5569	Oriya	6164	Tagalog	6658		
Armenian	5471	Hindi	5455	Oromo(Afan)	6159	Tajik	6653		
Assamese	4765	Hungarian [HUN]	5467	Panjabi	6247	Tamil	6647		
Aymara	4771	I-K				Pashto; Pushto	6265	Tatar	6666
Azerbaijani	4772	Icelandic [ICE]	5565	Persian	5247	Telugu	6651		
Bashkir	4847	Indonesian	5560	Polish [POL]	6258	Thai	6654		
Basque	5167	Interlingua	5547	Portuguese [POR]	6266	Tibetan	4861		
Bengali; Bangla	4860	Interlingue	5551	Quechua	6367	Tigrinya	6655		
Bhutani	5072	Inupiak	5557	Rhaeto-Romance	6459	Tonga	6661		
Bihari	4854	Irish [IRI]	5347	Romanian [RUM]	6461	Tsonga	6665		
Bislama	4855	Italian [ITA]	5566	Russian [RUS]	6467	Turkish [TUR]	6664		
Breton	4864	Japanese [JPN]	5647	S				Turkmen	6657
Bulgarian	4853	Javanese	5669	Samoan	6559	Twi	6669		
Burmese	5971	Kannada	5760	Sangho	6553	U-Z			
Byelorussian	4851	Kashmiri	5765	Sanskrit	6547	Ukrainian	6757		
C-E				Kazakh	5757	Urdu	6764		
Cambodian	5759	Kinyarwanda	6469	Scots Gaelic	5350	Uzbek	6772		
Catalan	4947	Kirghiz	5771	Serbian	6564	Vietnamese	6855		
Chinese [CHI]	7254	Kirundi	6460	Serbo-Croatian	6554	Volapuk	6861		
Corsican	4961	Korean [KOR]	5761	Sesotho	6566	Welsh	4971		
Croatian	5464	Kurdish	5767	Setswana	6660	Wolof	6961		
Czech [CZE]	4965	L-N				Shona	6560	Xhosa	7054
Danish [DAN]	5047	Laothian	5861	Sindhi	6550	Yiddish	5655		
Dutch [DUT]	6058	Latin	5847	Singhalese	6555	Yoruba	7161		
English [ENG]	5160	Latvian; Lettish	5868	Siswat	6565	Zulu	7267		
Esperanto	5161	Lingala	5860	Slovak	6557				
Estonian	5166	Lithuanian	5866	Slovenian	6558				
F-H				Macedonian	5957				
Faroese	5261	Malagasy	5953						
Fiji	5256	Malay	5965						
Finnish [FIN]	5255	Malayalam	5958						
French [FRE]	5264	Maltese	5966						
Frisian	5271	Maori	5955						
Galician	5358	Marathi	5964						
Georgian	5747	Moldavian	5961						

If you choose a language that has a 3 letter language code, the code will be displayed every time you change the AUDIO or SUBTITLE language setting. If you choose any other languages, '---' will be displayed instead. (3 letter language code is written in bracket.)

SPECIFICATIONS

GENERAL SPECIFICATIONS

TV	
CRT:	13 inch in-line gun, 90° deflection tube
Television system:	NTSC-M
Closed caption system:	§15.119/FCC
Tuner channel	
TV VHF Low:	#2~#6
TV VHF High:	#7~#13
TV UHF:	#14~#69
CATV	
VHF:	5A
MID band:	A5~A1, A~I
SUPER band:	J~W
HYPER band:	W+1~W+84

DVD	
Product type:	DVD Player
Discs:	DVD video, Audio CD
Output signal format:	NTSC color

ELECTRICAL SPECIFICATIONS

Sound output:	1 speaker, 1W, 8 ohm
---------------	----------------------

OTHER SPECIFICATIONS

Terminals	
Antenna input:	VHF/UHF/CATV 75 ohm unbalanced (F-type)
Video input:	RCA connector × 1
Audio input:	RCA connector × 1
Headphone:	1/8" (3.5 mm) miniature jack
Remote control:	Digital encoded infrared light system
Operating temperature:	5°C to 40°C (41°F~104°F)
Power requirements:	AC 120 V, 60 Hz
Power consumption (Maximum):	70 W
Picture tube:	13"
Dimensions:	H: 13" (330mm) W: 13-7/8" (353mm) D: 14-13/16" (377mm)
Weight:	19.4 lbs. (8.8kg)

- Designs and specifications are subject to change without notice.
- If there is a discrepancy between languages, the default language will be English.

ÍNDICE DE CONTENIDO

PREPARATIVOS PARA EL USO29
 CONEXIONES DE ANTENA/CABLE29
 CONEXIÓN A UN DISPOSITIVO EXTERNO
 (FRONTAL)30

SECCIÓN TV

FUNCIONAMIENTO Y AJUSTES DEL TELEVISOR31
 INSTALACIÓN INICIAL31
 PARA VER UN PROGRAMA DE TELEVISIÓN . . .31
 AJUSTE DE CANAL32
 IDIOMA DE MENÚ DE PANTALLA32

SECCIÓN DVD

REPRODUCCIÓN BÁSICA33
 MENÚ DE DISCO/MENÚ DE TÍTULO33

P REPARATIVOS PARA EL USO

CONEXIONES DE ANTENA/CABLE

Enchufe el cable entrante en la toma ANT., en la parte trasera de la unidad.
 Si su servicio de cable le suministra una caja convertidora o si usted utiliza un sistema de satélite, conecte la caja con esta unidad, como se indica a continuación.

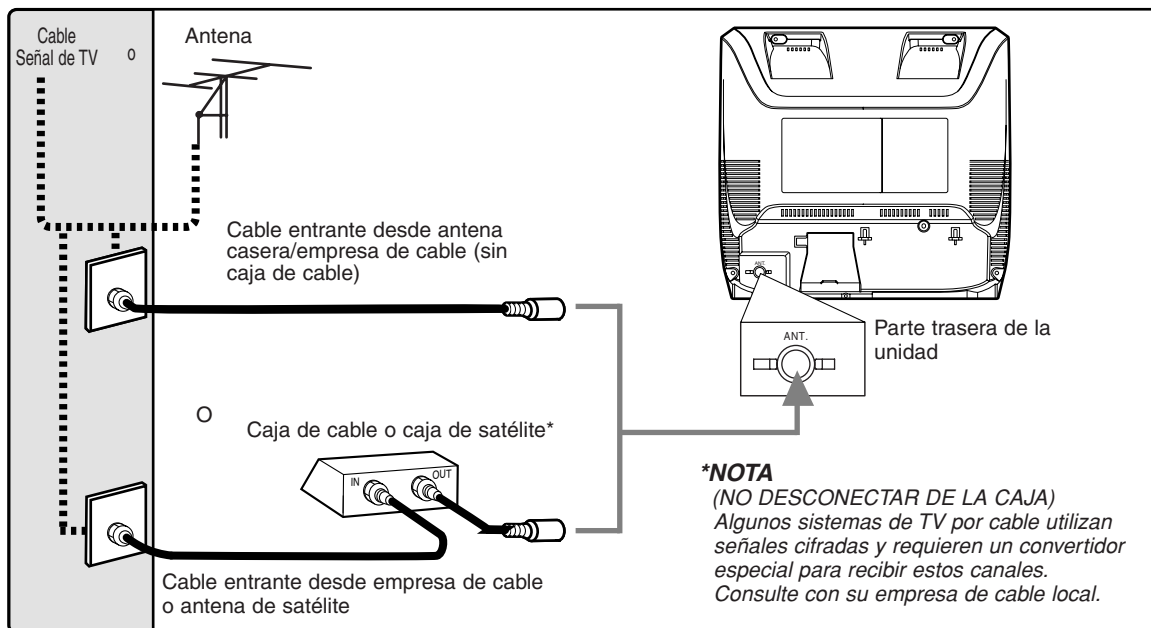

NOTA:

Antes de enchufar la antena en la toma ANT. de la unidad, compruebe que la patilla no está doblada. Si está doblada, enderece la patilla como se indica en la ilustración y enchufe la patilla a la toma ANT. de la unidad.

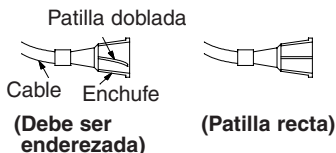

Para su seguridad y para evitar daños en la unidad, desenchufe el cable de la antena de la toma ANT. antes de mover la unidad.

PREPARATIVOS PARA EL USO

CONEXIÓN A UN DISPOSITIVO EXTERNO (FRONTAL)

Cuando vea un programa grabado en otra fuente (videograbadora o videocámara), utilice las tomas de entrada AUDIO/VIDEO en la parte frontal de la unidad.

Conecte las tomas de salida de Audio/Vídeo de otra fuente a la toma AUDIO y VIDEO de esta unidad.

A continuación, utilice [SELECT] o [CH. ▲ / ▼] hasta que aparezca "AUX" en la pantalla.

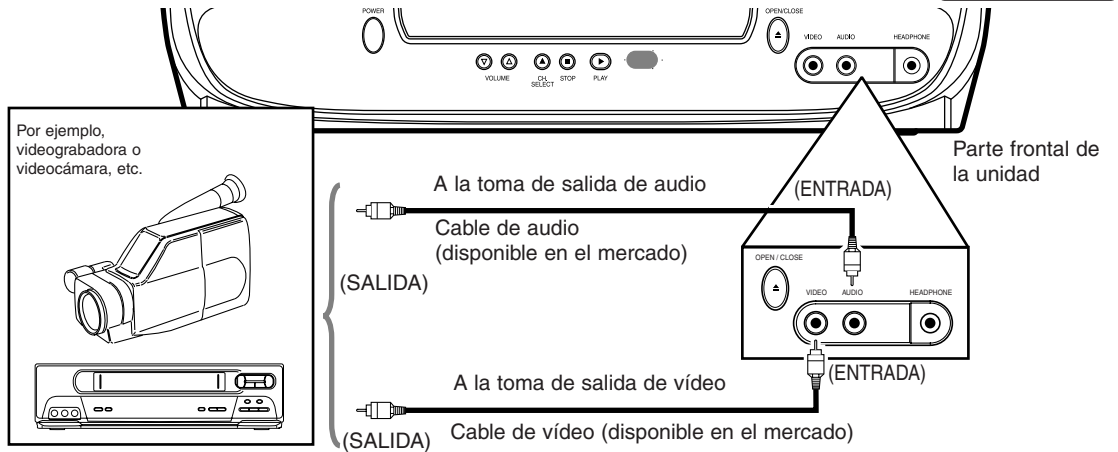

FUNCIONAMIENTO Y AJUSTES DEL TELEVISOR

INSTALACIÓN INICIAL

Cuando se enciende la unidad por primera vez, se muestra la pantalla de IDIOMA INICIAL. Seleccione el idioma de visualización de pantalla y ejecute la autoprogramación del canal.



1 Después de finalizar la conexión de la antena o del cable, conecte el cable de alimentación a una toma estándar de CA.

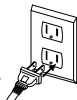

2 Presione [POWER] para encender la unidad.

3 Presione cualquier tecla para seleccionar el idioma del menú de pantalla.

- ENGLISH: [VOL. ▽]
- ESPAÑOL: [VOL. ▲]
- FRANÇAIS: [CH. ▲]

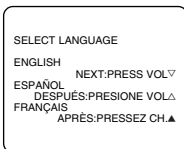

4 Confirme la conexión de la antena (o del cable) y presione [PLAY ▶].

- El sintonizador explora y memoriza todos los canales activos de su zona.

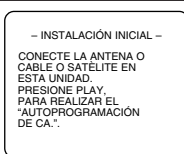

5 Cuando la exploración ha finalizado, el sintonizador se detiene en el canal memorizado más bajo.

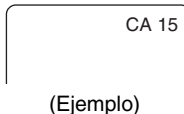

(Ejemplo)

NOTAS:

- Puede salir del menú INSTALACIÓN INICIAL presionando [SET-UP]. Si el botón se presiona durante la exploración de canales, el sintonizador interrumpe la exploración y se muestra el canal memorizado más bajo.
- El menú INSTALACIÓN INICIAL se muestra cada vez que usted enciende la unidad a menos que la exploración se haya finalizado.
- En caso de que no pueda recibirse ningún canal mediante la exploración de canales, "NO HAY SEÑAL DE TV" aparece en pantalla. Apague la unidad y compruebe la conexión de la antena; a continuación, siga los pasos 1 a 5 otra vez.



- Puede cambiar el después de finalizar la INSTALACIÓN INICIAL mediante el menú IDIOMA o el menú AJUSTE DE CANAL. (Consulte "IDIOMA DE MENÚ DE PANTALLA" o "AJUSTE DE CANAL" en página 32).

PARA VER UN PROGRAMA DE TELEVISIÓN

1 Presione [POWER] para encender la unidad.



NOTES:

Si la pantalla del televisor muestra interferencias "de nieve" y no funciona bien durante más de 10 segundos, aparecerá "SUGERENCIAS ÚTILES".

- SUGERENCIAS ÚTILES -
- 1. VERIFIQUE ANTENA/CABLE/ SATELITE ESTÁ BIEN CONECTADO.
- 2. VERIFIQUE "AUTOPROGRAMACIÓN DE CA." ESTÁ BIEN AJUSTADO.
- 3. LEA LA PÁGINA FRONTAL DEL MANUAL DEL USUARIO O PANEL TRASERO PARA EL NO. TEL. DE AYUDA A LOS CLIENTES.

- Compruebe si la antena o el cable están conectados correctamente. (Consulte "CONEXIONES DE ANTENA/CABLE" en página 29).
- Ajuste "AUTOPROGRAMACIÓN DE CA." en el menú de AJUSTE DE CANAL. (Consulte "AJUSTE DE CANAL" en página 32).
- Si pese a todo esos ajustes no funcionan correctamente, llame a nuestro teléfono de asistencia (en la página frontal en este manual del usuario).

2 Utilice [CH. ▲ / ▼] o los botones numéricos para seleccionar el número de canal deseado.

Para utilizar los botones numéricos

- Canales de un dígito: (Ej.: 02, 03, 04, etc.) Presione primero [0] para seleccionar un canal de un dígito.
- Canales de dos dígitos: (Ej.: 12, 38, 95 ...) Presione dos dígitos directamente.
- Canales de tres dígitos: (Ej. 115, 125 ...) Presione primero [+100], y luego presione los últimos dos dígitos.

3 Utilice [VOL. ▲ / ▼] para ajustar el volumen.

Presione [MUTE] para silenciar al instante el sonido. Presione de nuevo para restaurar el nivel de sonido anterior.



NOTA:

- Incluso aunque apague la unidad en el modo DVD, la unidad estará en el modo TV cuando vuelva a encenderse.

PARA VER UN CANAL DE CABLE O SATELITE

Si la unidad está conectada a una caja de cable o de satélite, utilice [CH. ▲ / ▼] para seleccionar CA3 o CA4 según el ajuste de canal de salida del dispositivo y seleccionar el canal deseado en dicho dispositivo.

PARA VER UNA ENTRADA EXTERNA

Cuando un equipo externo esté conectado a las tomas de entrada frontales AUDIO/VIDEO, presione [SELECT] o [CH. ▲ / ▼] repetidamente hasta que aparezca "AUX" en la pantalla.

AUX

AJUSTE DE CANAL

Es necesario preseleccionar el canal al principio o en caso de haber movido el televisor a una zona distinta.



AUTOPROGRAMACIÓN DEL CANAL

1 Presione [SET-UP].

Utilice [▲ / ▼] para ir hasta "AJUSTE DE CANAL", y presione [ENTER].

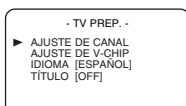

2 Utilice [▲ / ▼] para ir hasta "AUTOPROGRAMACIÓN DE CA.", y presione [ENTER].

El sintonizador explora y memoriza todos los canales activos de su zona.

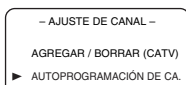

3 Cuando la exploración ha finalizado, se muestra el canal memorizado más bajo.

Si en la pantalla del televisor aparece "NO HAY SEÑAL DE TV", compruebe la conexión de la antena y vuelva a intentar.

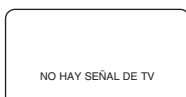
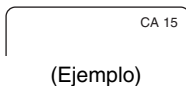

NOTAS:

- La unidad puede reconocer canales de CATV como canales de TV si el estado de la recepción es deficiente. En tal caso, compruebe la conexión de la antena y vuelva a intentar "AUTOPROGRAMACIÓN DE CA."
- La autoprogramación del canal NO es necesaria cuando está conectado a una caja de cable o de satélite. Simplemente seleccione el canal para entrada de caja de cable o de satélite (ej. CA3 o CA4) en la unidad, y seleccione el canal deseado en la caja de cable o de satélite.

IDIOMA DE MENÚ DE PANTALLA

Puede seleccionar el idioma del menú de pantalla entre inglés, español y francés.



1 Presione [SET-UP].

Utilice [▲ / ▼] para ir hasta "IDIOMA".

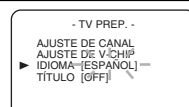

2 Presione [ENTER] repetidamente para seleccionar "ENGLISH", "ESPAÑOL" o "FRANÇAIS".

3 Presione [SET-UP] para salir del menú.

NOTAS:

- Esta función afecta solamente al idioma del menú de pantalla y no a la fuente de sonido.
- Si por alguna razón el menú ya está en inglés o en francés, presione [SET-UP] y mediante [▲ / ▼] vaya a "LANGUAGE [ENGLISH]" o "LANGAGE [FRANÇAIS]", y presione [ENTER] repetidamente para seleccionar el idioma deseado, y presione [SET-UP].

REPRODUCCIÓN BÁSICA

1 Presione [**POWER**] para encender la unidad.



2 Presione [**OPEN/CLOSE** ▲].

3 Coloque el disco en la bandeja, con la etiqueta hacia arriba.

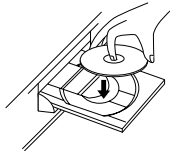

4 Presione [**PLAY** ▶].

• La bandeja se cerrará automáticamente y se empezará la reproducción. Cuando reproduzca un DVD que incluya un menú de títulos, este menú puede aparecer en pantalla.

NOTAS:

- Cerrar la bandeja del disco manualmente o presionando [**OPEN/CLOSE** ▲] también inicia la reproducción.
- Con discos DVD que utilicen títulos para señales de programa de reproducción, la reproducción puede comenzar desde el segundo título o puede omitir dichos títulos.

5 Para congelar la imagen, presione [**PAUSE** II] durante la reproducción.

NOTA:

- El sonido se silenciará en modo de pausa.

6 Presione [**STOP** ■] para interrumpir temporalmente la reproducción.

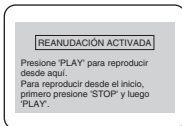

• Presione [**PLAY** ▶] para reanudar la reproducción.
• Para cancelar la reanudación y parar el disco, presione [**STOP** ■] de nuevo.

NOTAS:

- La información de reanudación se conserva aunque se apague la unidad.
- Puede aparecer un "icono prohibido" en la zona superior derecha de la pantalla del televisor durante la operación. Esto significa que la operación no está disponible en el disco.

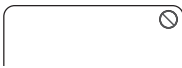

REPRODUCCIÓN PASO A PASO

• Durante la reproducción, presione [**PAUSE** II].



Puede avanzar la imagen fotograma a fotograma presionando repetidamente [**PAUSE** II].

• Para volver a la reproducción normal, presione [**PLAY** ▶].

AVANCE RÁPIDO / RETROCESO RÁPIDO

• Durante la reproducción, mantenga presionado [**FWD** ▶▶] para avance rápido o [**REV** ◀◀] para retroceso rápido.



• Cada vez que mantenga presionado el botón, la reproducción se acelera y el nivel de velocidad aparece en la pantalla.



NOTAS:

- En los discos DVD, la velocidad de avance/retroceso rápido es diferente según el disco. La velocidad aproximada es 1 (x2), 2 (x8), 3 (x20), 4 (x50) y 5 (x100).
- En discos de CD de audio la velocidad aproximada es 1 (x2), 2 (x8) y 3 (x30).

• Para volver a la reproducción normal, presione [**PLAY** ▶].

AVANCE LENTO / RETROCESO LENTO

• Durante la reproducción, presione [**PAUSE** II].



• Mantenga presionado [**FWD** ▶▶] para avance lento o [**REV** ◀◀] para retroceso lento.
• Cada vez que mantenga presionado el botón, la reproducción se ralentiza y el nivel de velocidad aparece en la pantalla.



NOTA:

- La velocidad de avance/retroceso lento varía según el disco. La velocidad aproximada es 1 (1/16), 2 (1/8) y 3 (1/2).

• Para volver a la reproducción normal, presione [**PLAY** ▶].

MENÚ DE DISCO/MENÚ DE TÍTULO

Un DVD puede contener menús para explorar el disco y acceder a funciones especiales.



1 Presione [**DISC MENU**] o [**TITLE**].

• Aparecerá el menú principal/menú de título del DVD.
• Puede activar el menú incluso durante la reproducción.

2 Utilice [▲ / ▼ / ◀ / ▶] para seleccionar un elemento y presione [**ENTER**].

NOTAS:

- Si el disco tiene un menú de disco, aparecerán distintas opciones de selección: idioma de sonido, subtítulos, capítulos del título y otras.
- El contenido del menú y las correspondientes operaciones de menú pueden variar según los discos. Para más detalles, consulte el manual que acompaña el disco.

MEMO

MEMO

SYLVANIA

LIMITED WARRANTY

FUNAI CORP. will repair this product, free of charge in the USA in the event of defect in materials or workmanship as follows:

DURATION:

PARTS: FUNAI CORP. will provide parts to replace defective parts without charge for one (1) year from the date of original retail purchase. Two (2) years for Picture Tube. Certain parts are excluded from this warranty.

LABOR: FUNAI CORP. will provide the labor without charge for a period of ninety (90) days from the date of original retail purchase.

LIMITS AND EXCLUSIONS:

THIS WARRANTY IS EXTENDED ONLY TO THE ORIGINAL RETAIL PURCHASER. A PURCHASE RECEIPT OR OTHER PROOF OF ORIGINAL RETAIL PURCHASE WILL BE REQUIRED TOGETHER WITH THE PRODUCT TO OBTAIN SERVICE UNDER THIS WARRANTY.

This warranty shall not be extended to any other person or transferee.

This warranty is void and of no effect if any serial numbers on the product are altered, replaced, defaced, missing or if service was attempted by an unauthorized service center. This limited warranty does not apply to any product not purchased and used in the United States.

This warranty only covers failures due to defects in material or workmanship which occurs during normal use. It does not cover damage which occurs in shipment, or failures which are caused by repairs, alterations or product not supplied by FUNAI CORP., or damage which results from accident, misuse, abuse, mishandling, misapplication, alteration, faulty installation, improper maintenance, commercial use such as hotel, rental or office use of this product or damage which results from fire, flood, lightning or other acts of God.

THIS WARRANTY DOES NOT COVER PACKING MATERIALS, ANY ACCESSORIES (EXCEPT REMOTE CONTROL), ANY COSMETIC PARTS, COMPLETE ASSEMBLY PARTS, DEMO OR FLOOR MODELS.

FUNAI CORP. AND ITS REPRESENTATIVES OR AGENTS SHALL IN NO EVENT BE LIABLE FOR ANY GENERAL, INDIRECT OR CONSEQUENTIAL DAMAGES ARISING OUT OF OR OCCASIONED BY THE USE OF OR THE INABILITY TO USE THIS PRODUCT. THIS WARRANTY IS MADE IN LIEU OF ALL OTHER WARRANTIES, EXPRESS OR IMPLIED, AND OF ALL OTHER LIABILITIES ON THE PART OF FUNAI, ALL OTHER WARRANTIES INCLUDING THE WARRANTY OF MERCHANTABILITY AND FITNESS FOR A PARTICULAR PURPOSE, ARE HEREBY DISCLAIMED BY FUNAI AND ITS REPRESENTATIVES IN THE UNITED STATES.

ALL WARRANTY INSPECTIONS AND REPAIRS MUST BE PERFORMED BY AN AUTHORIZED SERVICE CENTER. THIS WARRANTY IS ONLY VALID WHEN THE UNIT IS CARRIED-IN TO AN AUTHORIZED SERVICE CENTER.

IMPORTANT:

THIS LIMITED WARRANTY GIVES YOU SPECIFIC LEGAL RIGHTS. YOU MAY HAVE OTHER RIGHTS THAT VARY FROM STATE TO STATE. IF, AT ANY TIME DURING THE WARRANTY PERIOD, YOU ARE UNABLE TO OBTAIN SATISFACTION WITH THE REPAIR OF THIS PRODUCT, PLEASE CONTACT FUNAI CORP.

ATTENTION:

FUNAI CORP. RESERVES THE RIGHT TO MODIFY ANY DESIGN OF THIS PRODUCT WITHOUT PRIOR NOTICE.

To locate your nearest AUTHORIZED SERVICE CENTER or for general service inquiries, please contact us at:

FUNAI CORPORATION

Customer Service

Tel :1-800-968-3429

<http://www.SylvaniaConsumerElectronics.com>

19900 Van Ness Avenue, Torrance, CA 90501